

# Panasonic®

## Operating Instructions System Controller

Model No. **WV-CU650**

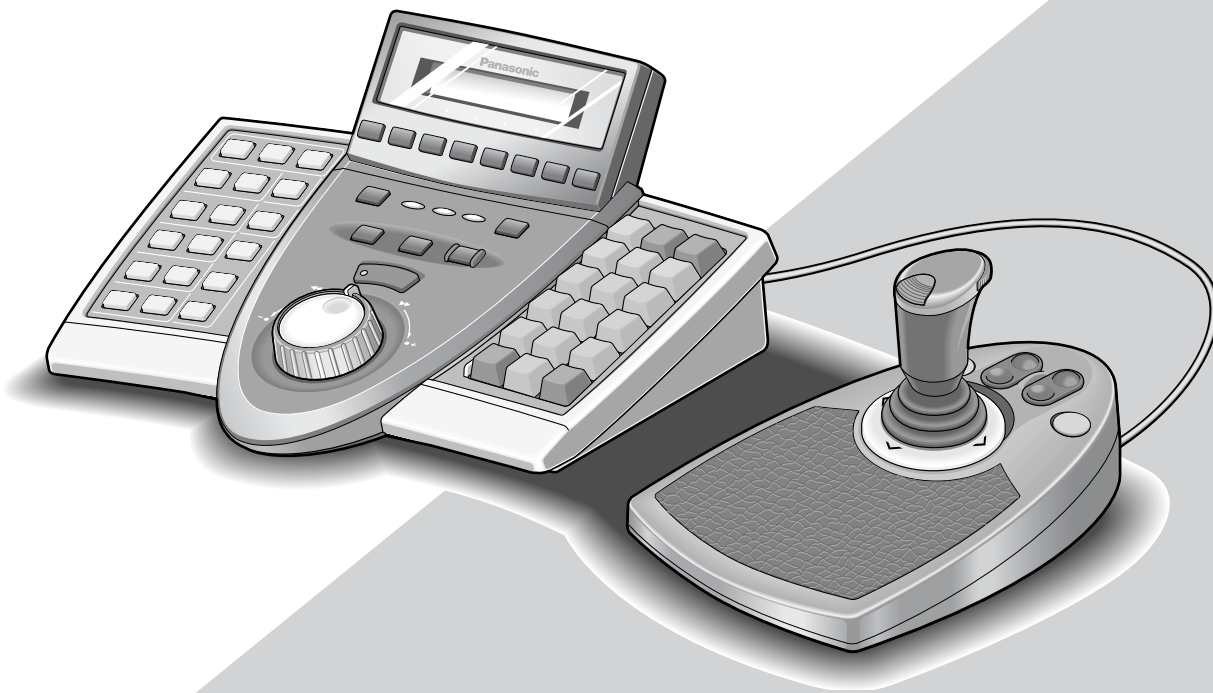

Before attempting to connect or operate this product,  
please read these instructions carefully and save this manual for future use.

# ENGLISH VERSION

**Caution:**

Before attempting to connect or operate this product, please read the label on the bottom.

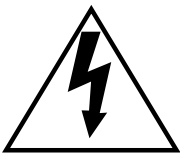
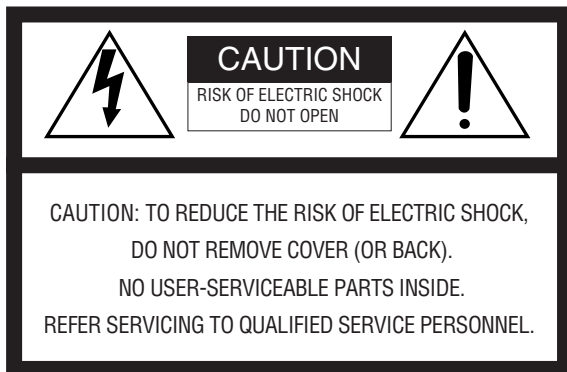

SA 1965

The lightning flash with arrowhead symbol, within an equilateral triangle, is intended to alert the user to the presence of uninsulated "dangerous voltage" within the product's enclosure that may be of sufficient magnitude to constitute a risk of electric shock to persons.



SA 1966

The exclamation point within an equilateral triangle is intended to alert the user to the presence of important operating and maintenance (servicing) instructions in the literature accompanying the appliance.

For U.S.A.

**NOTE:** This equipment has been tested and found to comply with the limits for a Class A digital device, pursuant to Part 15 of the FCC Rules. These limits are designed to provide reasonable protection against harmful interference when the equipment is operated in a commercial environment. This equipment generates, uses, and can radiate radio frequency energy and, if not installed and used in accordance with the instruction manual, may cause harmful interference to radio communications.

Operation of this equipment in a residential area is likely to cause harmful interference in which case the user will be required to correct the interference at his own expense.

**FCC Caution:** To assure continued compliance, (example - use only shielded interface cables when connecting to computer or peripheral devices). Any changes or modifications not expressly approved by the party responsible for compliance could void the user's authority to operate this equipment.

The serial number of this product may be found on the bottom of the unit.

You should note the serial number of this unit in the space provided and retain this book as a permanent record of your purchase to aid identification in the event of theft.

Model No. WV-CU650

Serial No. \_\_\_\_\_

**WARNING:** To prevent fire or electric shock hazard, do not expose this appliance to rain or moisture. The apparatus shall not be exposed to dripping or splashing and that no objects filled with liquids, such as vases, shall be placed on the apparatus.

# IMPORTANT SAFETY INSTRUCTIONS

- 1) Read these instructions.
- 2) Keep these instructions.
- 3) Heed all warnings.
- 4) Follow all instructions.
- 5) Do not use this apparatus near water.
- 6) Clean only with dry cloth.
- 7) Do not block any ventilation openings. Install in accordance with the manufacturer's instructions.
- 8) Do not use near any heat sources such as radiators, heat registers, stoves, or other apparatus (including amplifiers) that produce heat.
- 9) Do not defeat the safety purpose of the polarized or grounding-type plug. A polarized plug has two blades with one wider than the other. A grounding-type plug has two blades and a third grounding prong. The wide blade or the third prong are provided for your safety. If the provided plug does not fit into your outlet, consult an electrician for replacement of the obsolete outlet.
- 10) Protect the power cord from being walked on or pinched particularly at plugs, convenience receptacles and the points where they exit from the apparatus.
- 11) Only use attachments/accessories specified by the manufacturer.
- 12) Use only with the cart, stand, tripod, bracket, or table specified by the manufacturer, or sold with the apparatus. When a cart is used, use caution when moving the cart/apparatus combination to avoid injury from tip-overs.



- 13) Unplug this apparatus during lightning storms or when unused for long periods of time.
- 14) Refer all servicing to qualified service personnel. Servicing is required when the apparatus has been damaged in any way, such as power-supply cord or plug is damaged, liquid has been spilled or objects fallen into the apparatus, the apparatus has been exposed to rain or moisture, does not operate normally, or has been dropped.

# CONTENTS

IMPORTANT SAFETY INSTRUCTIONS .....	3	CAMERA CONTROL .....	40
PREFACE .....	5	■ Camera Panning/Tilting Control .....	40
FEATURES .....	5	■ Zooming Control .....	40
PRECAUTIONS .....	6	■ Lens Iris Control .....	40
LIMITATION OF LIABILITY .....	6	■ Lens Focus Control .....	40
DOCUMENT CONVENTION .....	7	■ Preset Position Control .....	41
NOTIFICATION ABOUT SYSTEM UNITS .....	7	■ Home Position Control .....	41
MAJOR OPERATING CONTROLS		■ Camera Function Control .....	41
AND THEIR FUNCTIONS .....	8	■ Camera Position Control .....	42
■ Main Unit .....	8	■ Camera Selection Recall .....	42
■ 3D Joystick Unit .....	12	■ Wiper Control .....	42
■ LCD Display Descriptions .....	13	■ Defroster Control .....	43
INSTALLATIONS AND CONNECTIONS .....	16	■ Auxiliary Control .....	43
■ Basic System Connections .....	16	■ Other Functions .....	43
■ Connection with the 3D Joystick Unit .....	17	ALARM CONTROL .....	44
■ Adjustment of 3D Joystick .....	17	■ System Controller Behavior	
SETUP PROCEDURES (HARDWARE) .....	18	during the Alarm Mode .....	44
■ Setup Procedures .....	18	■ Alarm Reset .....	44
■ MODE Switch Setting .....	18	■ Alarm Suspension .....	44
■ CONTROLLER NO. Switch Setting .....	18	■ Alarm History Search .....	44
SETUP PROCEDURES (FIRMWARE) .....	19	MENU FUNCTION DESCRIPTIONS .....	47
■ Administrator Password Entry .....	19	■ Menu Flow .....	47
■ Setting Modes .....	19	■ Menu Function Categories .....	48
■ All Reset .....	20	■ To Recall Menu Functions .....	51
■ PS-Data Communication Setting .....	20	■ Factory Default Setting of Button Functions	
■ To Change the Administrator Password .....	24	and Joystick Button Functions .....	52
■ Database Copy .....	25	■ To Assign Menu Functions to Function Buttons .....	52
■ PS-Data Operator Password Check .....	26	■ To Assign Menu Functions	
BEFORE OPERATION .....	27	to Joystick Function Buttons .....	53
■ Power-on .....	27	■ To Recall Button Functions	
■ Power-off .....	27	and Joystick Button Functions .....	53
■ Basic Operation Flow .....	28	■ To Check Button Functions	
■ LCD/BUZZER Adjustment .....	28	and Joystick Button Functions .....	54
■ Operation Start (Login) .....	29	MENU FUNCTION DETAILS .....	55
■ If You Have Forgotten the Login Password .....	30	■ Camera Functions .....	55
■ Operation Start (Auto Login) .....	30	■ Recorder Functions .....	57
■ Operation End (Logout) .....	30	■ System Functions .....	58
UNIT SELECTION .....	31	■ Controller Functions .....	60
■ System Unit Selection .....	31	■ Joystick Button Functions .....	69
■ Recorder Selection .....	31	TROUBLESHOOTING .....	74
■ Monitor Selection .....	32	SPECIFICATIONS .....	76
■ Camera Selection .....	32	STANDARD ACCESSORIES .....	76
SYSTEM UNIT CONTROL .....	33		
■ Multiscreen Display .....	33		
■ Electronic Zooming .....	33		
■ Tour Sequence/Group Sequence .....	33		
■ On-screen Display (OSD) Control .....	33		
■ System Function Control .....	34		
RECORDER CONTROL .....	35		
■ Manual Recording .....	35		
■ Playback .....	35		
■ Search Playback .....	35		
■ Time & Date Search Playback .....	38		
■ Other Available Functions .....	39		

# PREFACE

This product, System Controller WV-CU650, is designed for setup and operation of cameras and other system units installed in a surveillance system.

# FEATURES

- **This product can control cameras, matrix switchers, and recording devices such as digital disk recorders.**
- **One WV-CU650 System Controller can control two or more PS-Data system devices.**

In addition, up to 4 system controllers can be connected for multiple operation. The system controller has improved functions such as camera control, multiscreen segment switching, and search playback. These are fundamental functions to surveillance control systems.

- **Improved camera controllability**

This product has employed a 3D joystick which is separated from the main unit. You can control the camera zooming by moving the zoom wheel controller of joystick, so that you can control cameras and pan/tilt heads by holding the joystick with one hand.

- **Improved recorder controllability**

This product has employed the JogDial and shuttle ring to improve the control of recorded images.

- **Customization flexibility**

You can assign frequently-used functions to the function buttons. The function assignment is possible while watching the LCD.

- **Authentication by user ID's and passwords**

Operation authority (=user level) is assignable to each user ID. In addition, password is assignable to prevent inappropriate operations.

# PRECAUTIONS

- **Refer all work related to the installation of this appliance to qualified service personnel or system installers.**
- **Do not block the ventilation opening or slots on the cover.**

To prevent the appliance from overheating, place it at least 5 cm {2 inches} away from the wall.
- **Do not drop metallic parts through slots.**

This could permanently damage the appliance. Turn the power off immediately and contact qualified service personnel for service.
- **Do not attempt to disassemble the appliance.**

To prevent electric shock, do not remove screws or covers.  
There are no user-serviceable parts inside. Contact qualified service personnel for maintenance.
- **Do not expose nor operate the product in wet/damp conditions.**

Take immediate action if the product gets wet. Refer servicing to qualified service personnel. Moisture could damage the product and also cause electric shocks.
- **Handle the appliance with care.**

Do not strike or shake, as this may damage the appliance.
- **Do not expose the appliance to water or moisture. Do not try to operate it in wet areas.**

Take immediate action if the appliance gets wet. Turn the power off and refer servicing to qualified service personnel. Moisture can damage the appliance and also cause electric shocks.
- **Do not use strong or abrasive detergents when cleaning the appliance body.**

Use a dry cloth to clean the appliance when it is dirty. When the dirt is hard to remove, use a mild detergent and wipe gently.
- **Do not operate the appliance beyond its specified temperature, humidity, or power source ratings.**

Use the appliance at temperatures within  $-10^{\circ}\text{C}$  to  $+50^{\circ}\text{C}$  { $14^{\circ}\text{F}$  to  $122^{\circ}\text{F}$ } and humidity below 90 %.  
The input power source for this appliance is 120 V AC, 60 Hz.
- **Do not use any AC adapter other than the one supplied.**
- **Only use the appliance indoors.**

Do not install it in places where the appliance is exposed to sunlight for long periods of time or near air conditioning equipment. This will cause deformation, discoloration, breakdown or malfunction.

# LIMITATION OF LIABILITY

This product is a system controller to operate PS-Data system units and connected cameras. (A surveillance control system cannot be composed of this product alone.)

IN NO EVENT SHALL MATSUSHITA ELECTRIC INDUSTRIAL CO., LTD. BE LIABLE TO ANY PARTY OR ANY PERSON, EXCEPT FOR CERTAIN WARRANTY PROGRAM OFFERED BY THE LOCAL DEALER OF PANASONIC, FOR THE CASES INCLUDING BUT NOT LIMITED TO BELOW:

- (1) ANY DAMAGE AND LOSS, INCLUDING WITHOUT LIMITATION, DIRECT OR INDIRECT, SPECIAL, CONSEQUENTIAL OR EXEMPLARY, ARISING OUT OF OR RELATING TO THE PRODUCT;
- (2) PERSONAL INJURY OR ANY DAMAGE CAUSED BY INAPPROPRIATE USE OR NEGLIGENT OPERATION OF THE USER;
- (3) UNAUTHORIZED DISASSEMBLY, REPAIR OR MODIFICATION OF THE PRODUCT BY THE USER;
- (4) INCONVENIENCE OR ANY LOSS ARISING WHEN IMAGES ARE NOT DISPLAYED, DUE TO ANY REASON OR CAUSE INCLUDING ANY FAILURE OR PROBLEM OF THE PRODUCT;
- (5) ANY PROBLEM, CONSEQUENTIAL INCONVENIENCE, OR LOSS OR DAMAGE, ARISING OUT OF THE SYSTEM COMBINED BY THE DEVICES OF THIRD PARTY.

## DOCUMENT CONVENTION

This document uses the following convention when describing the use and operation of this unit.

**System controller:** Panasonic System Controller WV-CU650

**Caution(s):** Caution statements identify conditions or practices that could result in damage to this product or injury.

**Note(s):** Note statements identify special instruction, rule, or side comment related to the topic.

## NOTIFICATION ABOUT SYSTEM UNITS

Matrix Switcher WJ-SX150 Series Ver. 2.03 or later supports this system controller. However, some details on connections, settings, and operations are different from those described in this document. The different details are described in the following document.

Addendum for WV-CU650 and WJ-SX150 Series

# MAJOR OPERATING CONTROLS AND THEIR FUNCTIONS

## ■ Main Unit

### ● Front View

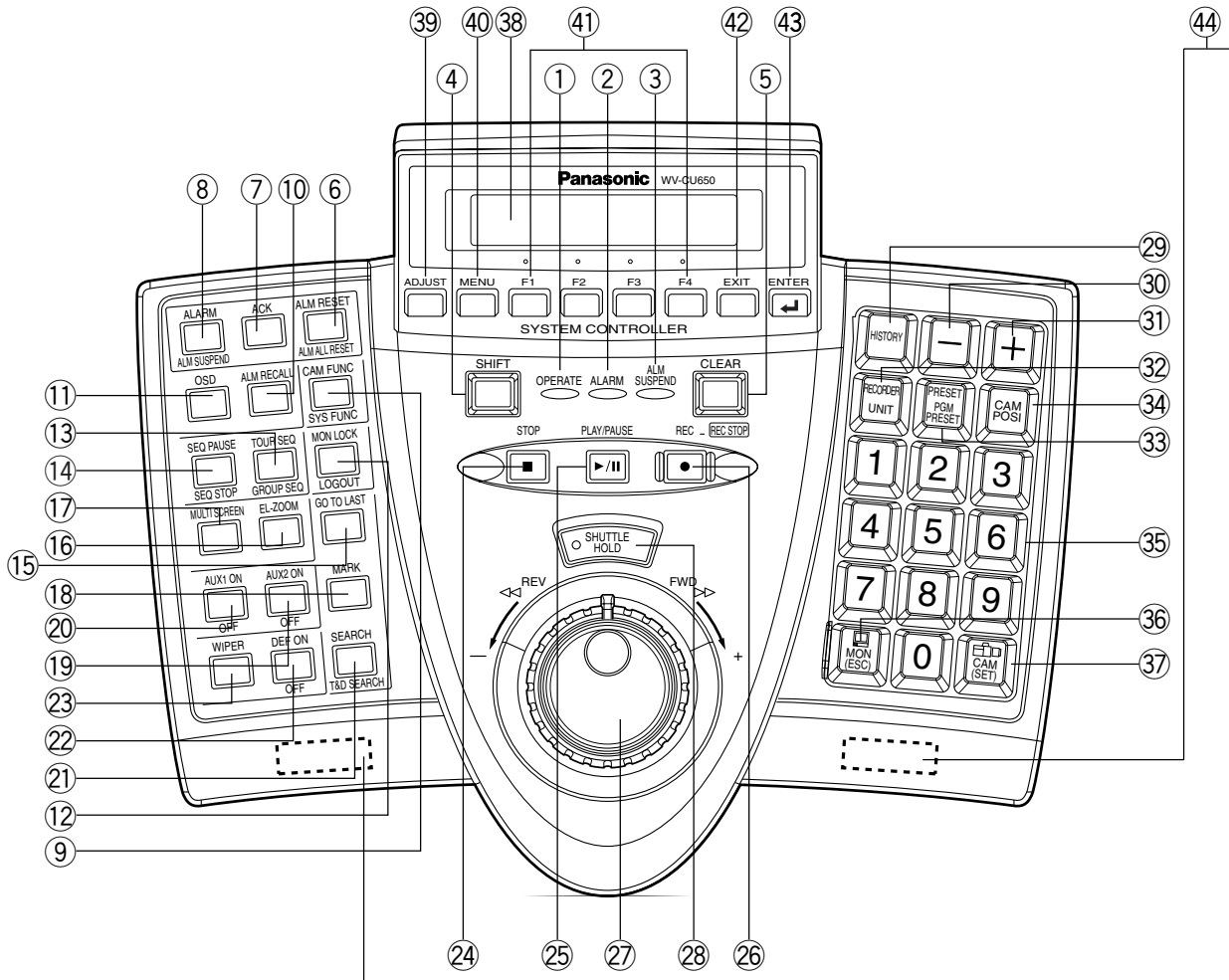

**Note:** Although printed on the template, some button functions are not mentioned here. These functions are reserved for future use.

#### ① Operation indicator (OPERATE)

This indicator is lighting while power is supplied to the system controller.

#### ② Alarm indicator (ALARM)

This indicator blinks when an alarm is activated. Blinking changes to steady light when the alarm is automatically reset.

#### ③ Alarm suspend indicator (ALM SUSPEND)

This indicator lights up when an alarm is suspended.

#### ④ Shift button (SHIFT)

To activate the alternate function of each button, press this button in combination with buttons associated with special functions.

#### ⑤ Clear button (CLEAR)

Clears the parameter entered with numeric buttons.

#### ⑥ Alarm reset/Alarm all reset button (ALM RESET/ALM ALL RESET)

This button cancels (resets) all the alarm inputs at a time.

**Note:** ALM ALL RESET is reserved for future use.

#### ⑦ Alarm Acknowledge button (ACK)

This button is reserved for future use.

#### ⑧ Alarm/Alarm suspend button (ALARM/ALM SUSPEND)

When you press while holding down the SHIFT button, this button temporarily stops alarm inputs to all the system units. When an alarm is suspended, "ALM SUSPEND" indicator lights up.

**Note:** ALARM is reserved for future use.



- ⑨ **Camera function/System function button (CAM FUNC/SYS FUNC)**
- Recalls a function of camera by the function number.
  - When you press while holding down the SHIFT button, this button recalls a function of external system unit by the function number.

- ⑩ **Alarm recall button (ALM RECALL)**  
Displays the log of alarms activated in the past.

- ⑪ **On-screen display button (OSD)**  
Toggles the display items on the active monitor.

- ⑫ **Monitor lock/Logout button (MON LOCK/LOGOUT)**  
When you press while holding down the SHIFT button, you can log out of the system.

**Note:** MON LOCK is reserved for future use.

- ⑬ **Tour sequence/Group sequence button (TOUR SEQ/GROUP SEQ)**  
Runs an assigned tour or group sequence on a selected monitor for the specified duration.

**Note:** GROUP SEQ (group sequence) is reserved for future use.

- ⑭ **Sequence pause/Sequence stop button (SEQ PAUSE/SEQ STOP)**
- Pauses a sequence.
  - When you press while holding down the SHIFT button, this button stops a sequence.

- ⑮ **Go to last button (GO TO LAST)**  
Plays back the latest recorded image.

- ⑯ **Electronic zoom button (EL-ZOOM)**  
Enlarges an image presently displayed on an active monitor.

- ⑰ **Multiscreen selection button (MULTI SCREEN)**  
Divides a monitor screen in multiscreen segments to display camera images simultaneously. Every pressing this button can change multiscreen segment patterns. (The available patterns differ depending on recorders.)

- ⑱ **Mark button (MARK)**  
When you press this button during playback, playback start point will be marked. You can start playback at the start point. (Refer to the operating instructions of recorder.)

**Note:** This button is available only for Digital Disk Recorder WJ-HD300 Series.

- ⑲ **Auxiliary 2 ON/OFF button (AUX 2 ON/OFF)**
- Turns on an auxiliary device (AUX 2).
  - When you press while holding down the SHIFT button, this button turns off the auxiliary device (AUX 2).

- ⑳ **Auxiliary 1 ON/OFF button (AUX 1 ON/OFF)**
- Turns on an auxiliary device (AUX 1).
  - When you press while holding down the SHIFT button, this button turns off the auxiliary device (AUX 1).

- ㉑ **Search/Time and date search button (SEARCH/T&D SEARCH)**
- Activates search functions of recorders.
  - When you press this button while holding down the SHIFT button, the date and time appears on the LCD for time & date search playback.

- ㉒ **Defroster button (DEF ON/OFF)**
- Turns on a defroster of camera housing .
  - When you press while holding down the SHIFT button, this button turns off the defroster.

- ㉓ **Wiper button (WIPER)**  
Turns on or off a wiper of camera housing.

- ㉔ **Stop button (STOP)**  
Stops the playback of recorded images.

- ㉕ **Play/Pause button (PLAY/PAUSE)**
- Starts the search playback of recorded images.
  - When pressed during playback, this button pauses the playback.

- ㉖ **Recording button (REC)**
- Pressing this button starts recording by a recorder.
  - Pressing this button for two seconds stops the recording.

- ㉗ **Shuttle ring (Outside)/JogDial (Inside)**  
**Shuttle ring:**
- When rotated to the right, the playback image is fast-forwarded. (Fast-forward)
  - When rotated to the left, the image is rewound. (The playback speed differs depending on recorders.) (Fast reverse)
  - Moves the cursor to the next or previous item on the LCD.
  - Moves to the next or previous main item on the function list.

#### **JogDial:**

- Plays back recorded images frame by frame when this dial is rotated during playback pause. (Single frame skip)
- When rotated to the right, playback will be skipped to the next record. When there is no newer record, normal playback will be continued. (Skip)
- When rotated to the left, playback will be skipped to the previous record. When there is no former record, normal playback will be continued. (Skip)
- Selects a parameter setting or a character on setup menus.
- Moves to the next or previous sub item on the function list.

⑳ **Shuttle hold button (SHUTTLE HOLD)**

- If you press this button while rotating the shuttle ring, playback speed will be maintained even after removing a hand from the shuttle ring. (The LED indicator on this button blinks during the fast playback.)

**Note:** This operation differs from “Hold playback speed” performed by holding the shuttle ring of recorder. When you hold the playback speed from the system controller, the EL-ZOOM, MULTI-SCREEN, and OSD buttons are unavailable.

- If you press this button again, normal playback speed is recovered.

㉑ **History button (HISTORY)**

When you press the + or – button while holding down this button, camera images selected in the past are displayed in order or in reverse order.

㉒ **– button [–]**

This button is pressed when selecting a camera with the lower channel number. During setup, this button is pressed to decrease the value of selected parameter.

㉓ **+ button [+]**

This button is pressed when selecting a camera with the higher channel number. During setup, this button is pressed to increase the value of selected parameter.

㉔ **Recorder/Unit Selection button (RECORDER/UNIT)**

- Selects a recorder.
- When you press while holding down the SHIFT button, this button selects a system unit.

㉕ **Preset/Program preset button (PRESET/PGM PRESET)**

- Recalls a preset position or the home position of combination camera.
- When you press while holding down the SHIFT button, this button programs preset positions.

㉖ **Camera position button (CAM POSI)**

This button is pressed to select the camera position (the combination of camera number and preset position).

㉗ **Numeric buttons (0, 1 to 9)**

Enters camera numbers, monitor numbers, or unit numbers, etc.

㉘ **Monitor/Escape button (MON (ESC))**

- Selects a monitor.
- When pressed during setup, this button determines the current selection to return to the main menu.

㉙ **Camera/Set button (CAM (SET))**

- Selects a camera.
- When pressed during setup, this button selects an item to go to a submenu.

㉚ **LCD (Liquid Crystal Display)**

Displays the numbers of unit, monitor and camera currently selected. The LCD also displays the functions assigned to F1 to F8 buttons.

㉛ **Adjustment button (ADJUST)**

This button is pressed to perform the settings of LCD brightness, LCD contrast, alarm buzzer, or button buzzer.

㉜ **Menu button (MENU)**

Displays the list of menu functions on the LCD. Menu functions are assignable to the function buttons (F1 to F4/F5 to F8) or joystick function buttons (A, B, and top buttons).

㉝ **Function buttons (F1 to F4/F5 to F8)**

Recall button functions you assign.

**Note:** When you press while holding down the SHIFT button, the F1 to F4 buttons become F5 to F8.

㉞ **Exit button (EXIT)**

While a menu function, determined with the ENTER button, is being displayed on the LCD, this button is pressed to return to the upper menu.

㉟ **Enter button (ENTER)**

While menu functions are displayed on the LCD, this button is determines a function to assign.

㊱ **Feet**

When extending these feet, you can raise the front side by approx. 1 cm {0.39 in.}.

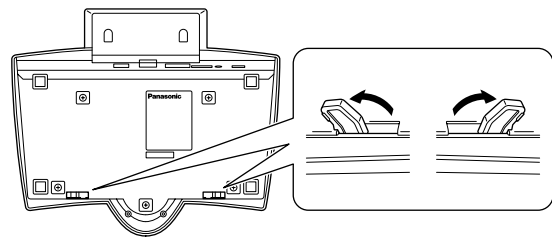

## ● Rear View

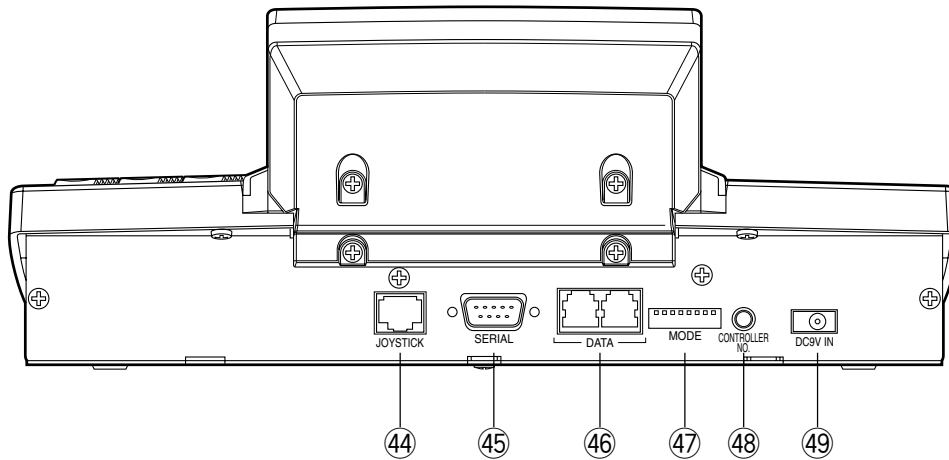

④④ **Joystick connector (JOYSTICK)**

This connector is used for connection with the joystick.

④⑤ **Serial port (SERIAL)**

This port is used for connection with a PC for system configuration.

④⑥ **Data ports (DATA)**

These ports are used for connection with the system controller and other system units. These ports are also used when adding other system controller connections.

④⑦ **Mode Selection switches (MODE)**

The operation mode of system controller is selected with these switches.

④⑧ **Controller Number switch (CONTROLLER NO.)**

When two or more system controllers are connected in the system, this switch determines the unit number of each controller. (Refer to p. 18 for the setting.) If connecting only one system controller in the system, set this switch to "1".

④⑨ **DC 9V Input jack (DC 9V IN)**

An AC adapter, supplied with the system controller, is plugged into this jack.

## ■ 3D Joystick Unit

This joystick unit is used to operate combination cameras and pan/tilt heads manually.

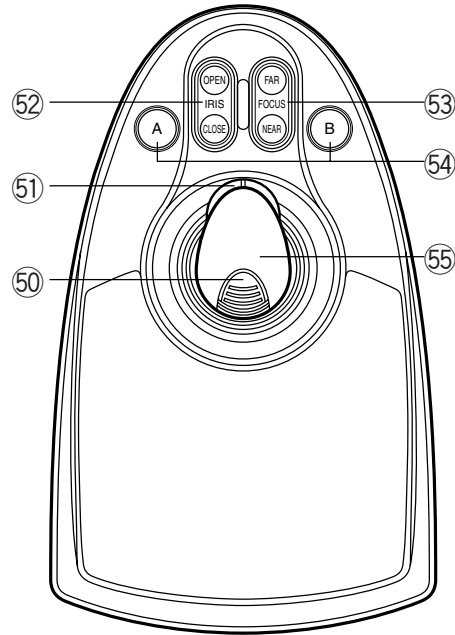

**50 Top button**

The top button is pressed to recall a function already assigned.

**51 Zoom wheel controller**

This controller is used for zooming cameras equipped with specific lenses.

**52 Iris control buttons (IRIS CLOSE, OPEN)**

These buttons close or open the lens iris of cameras equipped with specific lenses.

**53 Focus control buttons (FOCUS NEAR, FAR)**

These buttons adjust the lens focus of cameras equipped with specific lenses.

**54 A and B buttons (A, B)**

These buttons recall functions you assign.

**55 3D joystick**

Controls the panning and tilting of combination cameras and pan/tilt heads.

## ■ LCD Display Descriptions

The following are examples of LCD display after login.

**Note:** Some parts of LCD displays, described on this document, may differ from the actual status.

### ● Default Status (LCD Display After Login)

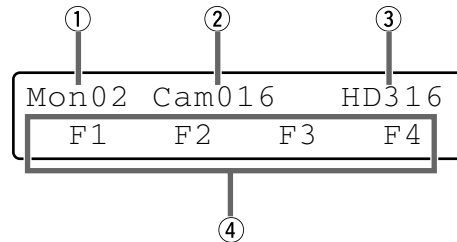

#### ① Monitor number

The number of connected monitor is displayed. 1 to 99 can be displayed as a monitor number.

#### ② Camera number

- The number of connected camera is displayed. 1 to 999 can be displayed as a camera number.
- When a camera position is specified, the camera position number is displayed.
- When a sequence is activated for a connected system unit, "Seq" is displayed.

#### ③ Model number/Unit number

- The model number of connected system unit is displayed. When you select a system unit, the unit number of connected system unit is displayed. The following are examples of model number display.

"**HD500**": Digital Disk Recorder WJ-HD500 Series

"**SX150A**": Matrix Switcher WJ-SX150A

**Note:** The model number is abbreviated when an actual model number exceeds 6 characters.

- When you press the RECORDER/UNIT button, the unit number of connected system unit appears. 1 to 99 can be displayed as a unit number.
- Numerics you have entered are displayed on this area.

#### ④ Function number (F1 to F8)/LCD title

- In the factory default, function numbers "F1" to "F4" are displayed. "F5" to "F8" are displayed while holding down the SHIFT button.
- The LCD titles, assigned to function buttons (F1 to F4/F5 to F8), can also be displayed. You can edit the function names in up to 20 alphanumeric characters. You can display F5 to F8 function names while holding down the SHIFT button.

## ● Main Menu (Menu Functions)

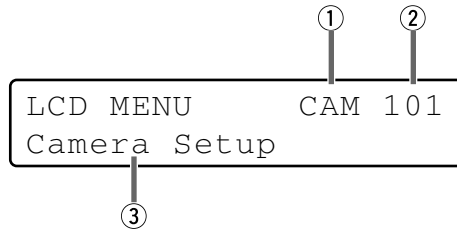

① **Category**

The category of selected menu function is displayed.

③ **Function name**

The name of selected menu function is displayed.

② **Function number**

The function number of selected menu function is displayed.

**Note:** Refer to p. 48 Menu Function Categories.

## ● Sub Menu (Menu Functions)

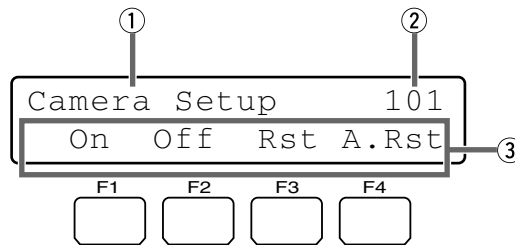

① **Menu name**

The name of selected menu function is displayed.

② **Function number**

The function number of selected menu function is displayed.

③ **Button actions**

The actions activated by the function (F1 to F4) buttons are displayed. When pressed while holding down the SHIFT button, actions of F5 to F8 buttons are displayed.

**Note:** When the selected button function has no button actions, nothing is displayed on this area.

## ● Blinking

In this document, grayed areas on the illustrations mean blinking.

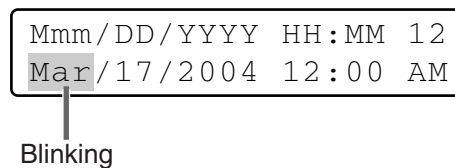

## ● Messages Displayed on the LCD

### Invalid

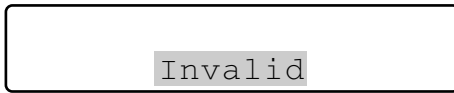

An LCD display showing the word "Invalid" in a monospaced font, centered on the screen.

This message is displayed in the following circumstances.

- When you have entered a wrong user ID or password, etc.
- When you have a camera number or menu number, etc. that is not existing.

### Busy

- When a selected monitor is controlled by a higher-level user, the monitor number and "Busy" blinks on the LCD. (You cannot control the monitor.)
- When a selected camera is controlled by a higher-level user, the camera number and "Busy" blinks on the LCD. (You cannot control the camera.)
- To cancel the Busy status, select another monitor, or wait until "Busy" goes out.

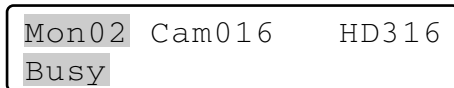

An LCD display showing "Mon02 Cam016 HD316" on the top line and "Busy" on the bottom line. The "Mon02" and "Busy" text are highlighted with a gray background.

"Busy" status is activated for a monitor.

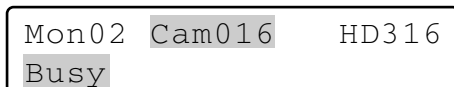

An LCD display showing "Mon02 Cam016 HD316" on the top line and "Busy" on the bottom line. The "Cam016" and "Busy" text are highlighted with a gray background.

"Busy" status is activated for a camera.

### Prohibited

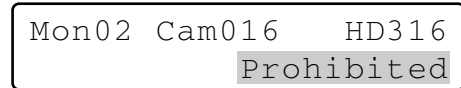

An LCD display showing "Mon02 Cam016 HD316" on the top line and "Prohibited" on the bottom line. The "Prohibited" text is highlighted with a gray background.

- When you have tried an operation not authorized by the function level setting, camera level setting, or selected system unit, "Prohibited" blinks on the LCD.
- When you have forgotten to select a system unit or monitor before selecting a camera, "Prohibited" blinks on the LCD.
- When you have selected a system unit disconnected from the system, "Prohibited" blinks on the LCD.
- After a few seconds, the LCD display will return to the default status.

#### Notes:

- After a few seconds, this message will automatically disappear.
- The illustration is an example in which a camera number other than 1 to 256 has been entered.
- In this document, gray area on illustration shows blinking.

### Controller No.1 No Exist Error



An LCD display showing "Controller No.1" on the top line and "No Exist Error" on the bottom line.

This message is displayed when no system controller is set to CONTROLLER NO.1. Check that a system controller is set to CONTROLLER NO. 1 (Refer to p. 18 CONTROLLER NO. Switch Setting.)

# INSTALLATIONS AND CONNECTIONS

## WARNING

The installations described in the figures should be made by qualified service personnel or system installers.

## Basic System Connections

The following is an example in which a recorder and data multiplex units are connected.

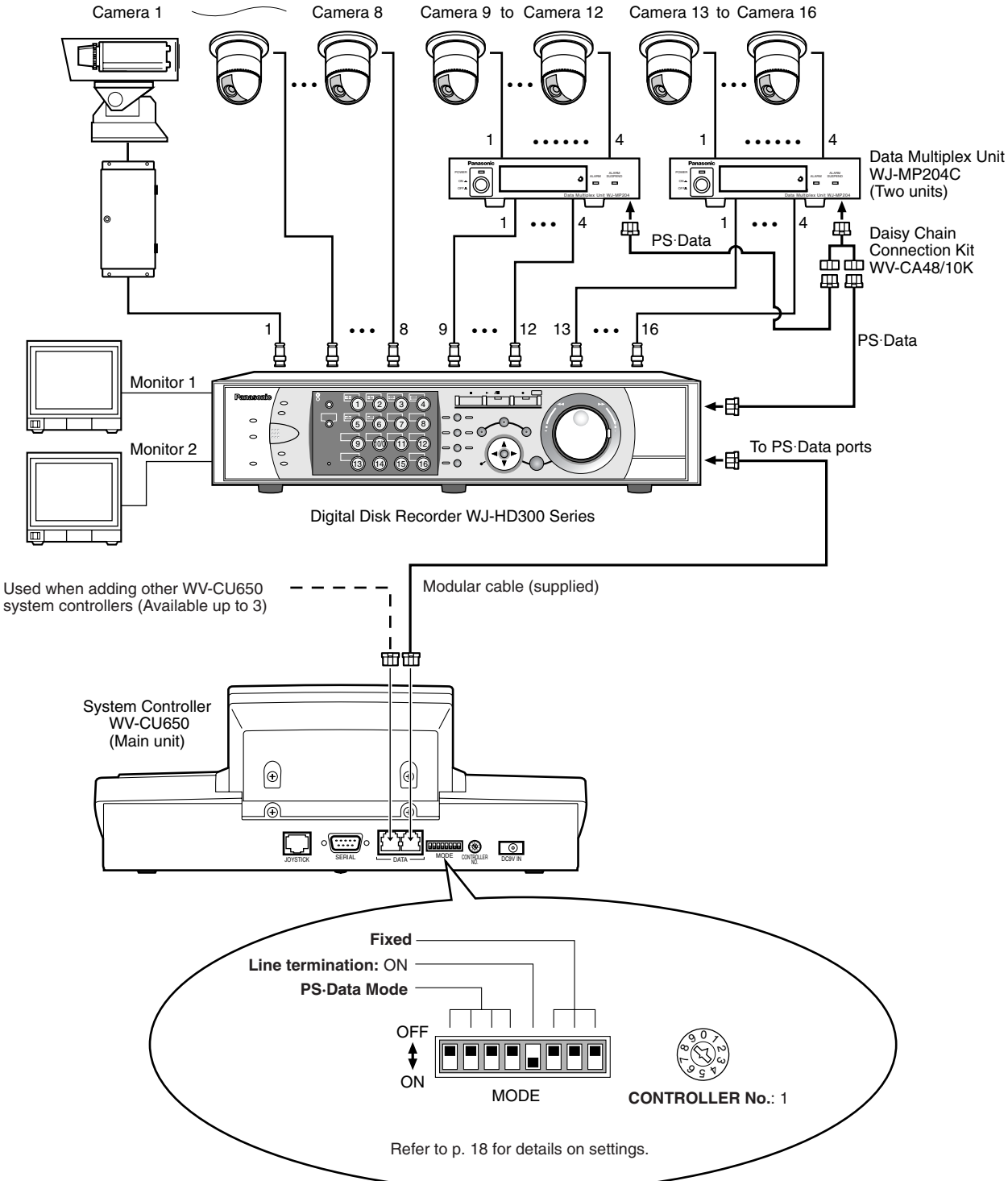



## ■ Connection with the 3D Joystick Unit

Connect the main unit and 3D joystick unit as follows.

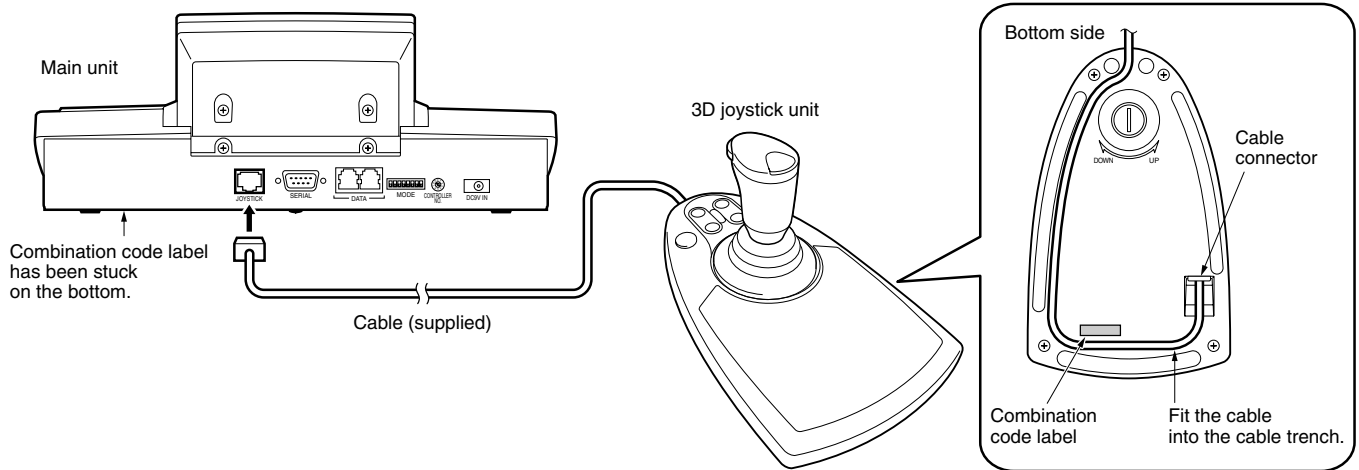

**Note:** Use the main unit and 3D joystick unit whose combination codes are identical.

## ■ Adjustment of 3D Joystick

To adjust the altitude of 3D joystick, turn the adjusting screw to the right or left.

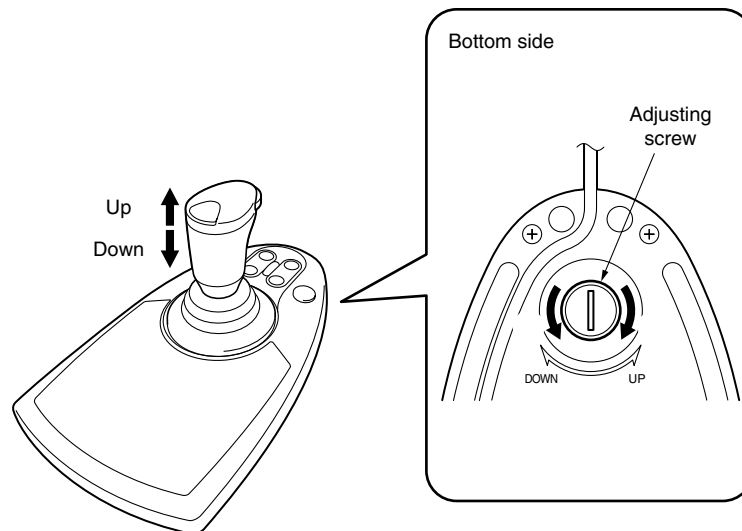

# SETUP PROCEDURES (HARDWARE)

## ■ Setup Procedures

Perform the setup as follows.

### 1. Set the MODE switches.

You will set up the communication mode and line termination ON/OFF of RS-485 communication. (Refer to MODE Switch Setting.)

### 2. Set CONTROLLER NO. switches.

You will perform this setting when using two or more system controllers in daisy chain connections. (Refer to CONTROLLER NO. Setting.)

### 3. Perform WV-CU650 setups after entering the administrator password.

You will perform the settings concerning password and communication between system controllers and other system units, etc. (Refer to p. 19.)

**Note:** Before performing WV-CU650 setups, you need to log into the system by entering the administrator password. (Refer to p. 19.)

## ■ MODE Switch Setting

You will perform the setting of the MODE switches at the rear panel.

### Notes:

- Before the setting, turn off the system controller. (Refer to p. 27 Power-off.)
- Do not move the MODE switches to positions other than described in these illustrations. That may cause malfunction.

## ● Setting for PS-Data Mode

### If using only one system controller

Set the MODE Switch #5 to ON.

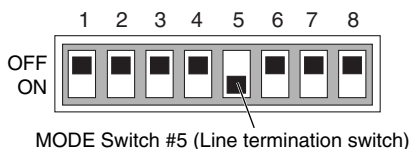

### If using two or more system controllers in daisy chain connections

1. Set the MODE Switch #5 of the system controller at the chain end to ON.

2. Set the Line termination switch of other system controllers to OFF.

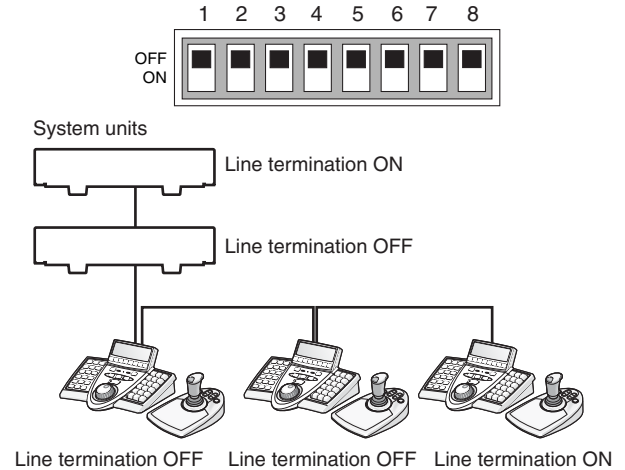

## ● Setting for Terminal Mode

Set the MODE Switch #1 and #5 to ON.

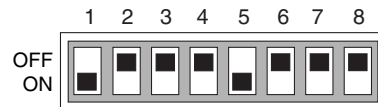

**Note:** Refer to the following document for details on connections and operations.

Addendum for WV-CU650 and WJ-SX150 Series

## ■ CONTROLLER NO. Switch Setting

You will determine controller-number settings by moving the CONTROLLER NO. switch at the rear panel.

### If using only one system controller

Maintain the switch setting as "1 (factory default position)".

### If using two or more system controllers in daisy chain connections

Up to 4 system controllers are connectable in the system. To avoid conflict, set the unique number for each system controller.



CONTROLLER No.

### Notes:

- "0" and "9" are reserved numbers. They cannot be set for controller numbers.
- One of the system controllers must be set to "1".

# SETUP PROCEDURES (FIRMWARE)

## ■ Administrator Password Entry

If you log into the system in the administrator mode, PS-Data communication setting, all reset, operator password check, and database copy will become available. To activate the administrator mode, you need to enter the administrator password.

### Notes:

- The factory default of administrator password is "650". However, for security, you should change the password setting. To change the setting, refer to p. 24.
- Take a note of your administrator password.

## ■ Setting Modes

If you power on the system controller while pressing the following buttons, the system will run in an associated setting mode.

### Notes:

- You cannot change the system from the following modes (refer to the diagram) to the normal operation mode. To start up the normal operation mode, turn off the system controller, and then turn on the controller again.
- The administrator password entry is required for the following modes.

Buttons pressed while the power-on	Setting Mode	Description
2, 4, and 6	All reset	The communication settings and PS-Data database can be restored to the factory default.*
MON (ESC) and 6	PS-Data Communication setting	PS-Data communication setting can be performed.
MON (ESC) and 1	Administrator password change	The administrator password can be changed.
MON (ESC) and 2	PS-Data database copy	The PS-Data database can be copied from the source system controller (Controller No. 1) to a destination system controller.
MON (ESC) and 4	PS-Data password display	The passwords of up to 16 operators can be displayed on the LCD.

\* The panning, tilting, and zooming calibration settings are not restored.

## ■ All Reset

When the all reset mode is activated, all of the following settings will be reset to the factory default.

- Administrator password
- PS-Data communication setting
- LCD brightness, contrast, alarm buzzer, and button buzzer settings
- Button functions and joystick button functions (F1 to F8, A, B, and top buttons)
- Controller functions
  - (Time & Date Type)
  - (Auto Login)
  - (Operator Setup)
  - (Function Level)
  - (Camera Level)
  - (Cam Posi Map)
  - (Cam-Unit Map)
  - (HDD-Unit Map)
  - (LCD Title)

**Note:** Calibration settings of panning, tilting, and zooming will be maintained even after all reset.

## ● Operation

### 1. Turn off the power.

**Note:** If you set the MODE Switch #1 to #4 to ON, you can skip entering the administrator password in Step 3.

### 2. Turn on the power while holding down the buttons 2, 4, and 6.

“Admin Password” will appear on the LCD to enter the password.

```
All Reset
Admin Password
```

### 3. Enter the administrator password.

The password entered will be displayed as “\*” marks.

```
All Reset
Admin Password *****
```

#### Notes:

- The factory default is “650”.
- To delete a character, press the CLEAR button.
- If you have entered a wrong password, the LCD display will return to Step 2.

### 4. Press the CAM (SET) button.

If the password entered is correct, all the settings will be reset to the factory default.

```
All Reset
```

### 5. Check “End” on the LCD.

Check “End” has appeared on the LCD to inform you of the initialization end.

```
All Reset
End
```

### 6. Turn off the power.

## ■ PS-Data Communication Setting

This setting is required to establish a connection between the system units and system controller.

### List of PS-Data communication settings

Setting Item	Available setting parameter(s)
Baud Rate	4800 / <u>9600</u> / 19200 bps
Data Bit	<u>8 bit</u> (Fixed)
Parity Bit	<u>None</u> / Odd / Even
Stop Bit	<u>1</u> / 2 bit
Wait Time	<u>OFF</u> / 100 msec / 200 msec / 400 msec / 1000 msec
Group Adr	<u>A</u> to Z
Xon/Xoff	Not Use (Fixed)

**Note:** Factory defaults are underlined.

## ● Operation

### 1. Turn off the power.

### 2. Turn on the power while holding down the button 6 and MON (ESC) button.

“Admin Password” will appear on the LCD to enter the password.

```
PS-Data Com. Setup
Admin Password
```

### 3. Enter the administrator password.

The password entered will be displayed as "\*" marks.

```
PS·Data Com. Setup
Admin Password *****
```

#### Notes:

- The factory default is "650".
- To delete a character, press the CLEAR button.

### 4. Press the CAM (SET) button.

If the password entered is correct, "Baud Rate" setting form will appear on the LCD.

```
PS·Data Com. Setup
Baud Rate 9600
```

#### Notes:

- If the password entered is wrong, "PS·Data Com. Setup" will appear on the LCD again to reenter the password.
- You can change the setting item display on the LCD by rotating the JogDial.

### 5. Select an item you wish to set up by rotating the JogDial.

#### Baud rate

```
PS·Data Com. Setup
Baud Rate 9600
```

The speed of communication between the system controller and other system units

#### Parity bit

```
PS·Data Com. Setup
Parity Bit None
```

The parity bit, added to the data, to perform parity check (Refer to p. 22 for details.)

#### Stop bit

```
PS·Data Com. Setup
Stop Bit 1
```

The stop bit, added to the last of data, in asynchronous communication (Refer to p. 22 for details.)

#### Wait time

```
PS·Data Com. Setup
Wait Time Off
```

The wait time until the data is sent again (Refer to p. 22 for details.)

#### Controller group address

```
PS·Data Com. Setup
Cnt G-Adr. A
```

(No need for setup) Remain the factory default.

#### System unit group address

```
PS·Data Com. Setup
Sys G-Adr.
```

(No need for setup) Remain the factory default.

### 6. Perform the settings.

Setting procedures differ depends on items. Refer to p. 21 to 23 for how to operate.

### 7. After you have completed the settings, turn off the power.

## ● Baud Rate Setting

#### 1. Select "Baud Rate" by rotating the JogDial.

(Refer to Step 5 in Operation.)

#### 2. Press the CAM (SET) button.

The LCD display will change from the display mode to the editing mode.

```
PS·Data Com. Setup
Baud Rate 9600
```

#### 3. Select a desired parameter by rotating the JogDial, or pressing the + or - button.

You can select the desired parameter from "19200", "9600", and "4800". The factory default is "9600".

```
PS·Data Com. Setup
Baud Rate 4800
```

**Note:** Conform this parameter to the baud rate of other system units. Otherwise, communication will not be established between the system controller and system units.

#### 4. Press the MON (ESC) button.

The selected parameter will be determined, and the LCD display will return from the editing mode to the display mode.

```
PS·Data Com. Setup
Baud Rate 4800
```

#### 3. Select a desired parameter by rotating the JogDial or pressing the + or – button.

You can select the desired parameter from “1” (bit) and “2”. The factory default is “1”.

```
PS·Data Com. Setup
Stop Bit 2
```

## ● Parity Bit Setting

#### 1. Select “Parity Bit” by rotating the JogDial.

(Refer to Step 5 in p. 21.)

#### 2. Press the CAM (SET) button.

The LCD display will change from the display mode to the editing mode.

```
PS·Data Com. Setup
Parity Bit None
```

#### 3. Select a desired parameter by rotating the JogDial or pressing the + or – button.

You can select the desired parameter from “None”, “Odd”, and “Even”. The factory default is “None”.

```
PS·Data Com. Setup
Parity Bit Even
```

#### 4. Press the MON (ESC) button.

The selected parameter will be determined, and the LCD display will return from the editing mode to the display mode.

```
PS·Data Com. Setup
Parity Bit Even
```

#### 4. Press the MON (ESC) button.

The selected parameter will be determined, and the LCD display will return from the editing mode to the display mode.

```
PS·Data Com. Setup
Stop Bit 2
```

## ● Wait Time Setting

#### 1. Select “Wait Time” by rotating the JogDial.

(Refer to Step 5 in p. 21.)

#### 2. Press the CAM (SET) button.

The LCD display will change from the display mode to the editing mode.

```
PS·Data Com. Setup
Wait Time Off
```

#### 3. Select a desired parameter by rotating the JogDial or pressing the + or – button.

You can select the desired parameter from “Off”, “100 (msec)”, “200”, “400”, and “1000”.

```
PS·Data Com. Setup
Wait Time 100
```

#### 4. Press the MON (ESC) button.

The LCD display will return from the editing mode to the display mode, and the selected parameter will be determined.

```
PS·Data Com. Setup
Wait Time 100
```

## ● Stop Bit Setting

#### 1. Select “Stop Bit” by rotating the JogDial.

(Refer to Step 5 in p. 21.)

#### 2. Press the CAM (SET) button.

The LCD display will change from the display mode to the editing mode.

```
PS·Data Com. Setup
Stop Bit 1
```

## ● Group Address Setting for System Controller

**Note:** Remain the factory default. When you have mistakenly changed the setting, recover the factory default as follows.

**1. Select “Cnt G-Adr.” by rotating the JogDial.**

(Refer to Step 5 in p. 21.)

**2. Press the CAM (SET) button.**

The LCD display will change from the display mode to the editing mode.

```
PS·Data Com. Setup
Cnt G-Adr. B
```

**3. Select a desired parameter by rotating the JogDial or pressing the + or – button.**

You can select the desired parameter from “A” to “Z”. The factory default is “A”.

```
PS·Data Com. Setup
Cnt G-Adr. A
```

**4. Press the MON (ESC) button.**

The selected parameter will be determined, and the LCD display will return to the display mode.

```
PS·Data Com. Setup
Cnt G-Adr. A
```

## ● Group Address Setting for System Units

**Note:** Remain the factory default. When you have mistakenly changed the setting, recover the factory default as follows.

**1. Select “Sys G-Adr.” by rotating the JogDial.**

(Refer to Step 5 in p. 21.)

**2. Press the CAM (SET) button.**

The LCD display will change from the display mode to the editing mode.

```
PS·Data Com. Setup
Sys G-Adr. B
```

**3. Select “A” by rotating the JogDial or pressing the + or – button.**

```
PS·Data Com. Setup
Sys G-Adr. A
```

**4. Press the CAM (SET) button.**

The parameter will be determined, and the cursor will jump to the sub parameter.

```
PS·Data Com. Setup
Sys G-Adr. A 05
```

**5. Enter the unit number of system unit by rotating the JogDial or pressing the + or – button.**

```
PS·Data Com. Setup
Sys G-Adr. A 01
```

**Note:** 1 to 99 is available for the unit number. The factory default is 01.

**6. Press the CAM (SET) button.**

The sub parameter will be determined, and “OK” will appear on the LCD.

```
PS·Data Com. Setup
Sys G-Adr. A 01 OK
```

After a second, the LCD display will return to the status in Step 5.

If you set the unit numbers of other system units, repeat Step 5.

**Note:** If the parameters cannot be determined, “NG” will appear on the LCD. In this case, check the unit number of system unit, and repeat Step 3 to 6.

**7. Press the MON (ESC) button.**

The LCD display will return to the status in Step 2.

**8. Press the MON (ESC) button again.**

The LCD display will return from the editing mode to the display mode.

## ■ To Change the Administrator Password

You can change the administrator password. The factory default is "650".

### ● Operation

#### 1. Turn off the power.

#### 2. Turn on the power while holding down the button 1 and MON (ESC) button.

"Admin Password" entry form will appear to perform the setting.

```
Admin Password Setup
Admin Password _____
```

#### 3. Enter the current administrator password.

The password entered will be displayed as "\*" marks.

```
Admin Password Setup
Admin Password *****
```

#### Notes:

- The factory default is "650".
- To delete a character, press the CLEAR button.

#### 4. Press the CAM (SET) button.

If the password entered is correct, "Old Password" entry form will appear.

```
Admin Password Setup
Old Password _____
```

#### 5. Enter the current administrator password again.

The password entered will be displayed as "\*" marks.

```
Admin Password Setup
Old Password *****
```

**Note:** To delete a character, press the CLEAR button.

#### 6. Press the CAM (SET) button.

If the password entered is correct, "New Password" entry form will appear.

```
Admin Password Setup
New Password _____
```

**Note:** If the old password entered is wrong, the LCD display will return to Step 4. Enter the old password again.

#### 7. Enter a new administrator password.

```
Admin Password Setup
New Password *****
```

#### 8. Press the CAM (SET) button.

"New Password" entry form will appear again.

```
Admin Password Setup
New Password _____
```

#### 9. Enter the new administrator password again.

The password entered will be displayed as "\*" marks.

```
Admin Password Setup
New Password *****
```

#### 10. Press the CAM (SET) button.

The new password has been memorized in the system, and "Memory" will appear on the LCD.

```
Admin Password Setup
Memory
```

Then, "End" will appear on the LCD.

```
Admin Password Setup
End
```

**Note:** If the new password entered is wrong, the LCD display will return to Step 4. Enter the old password again.

#### 11. Turn off the power.





The LCD display of destination system controller(s) becomes as follows.

```
Data Base Rx Mode
Completed Sum=1733
```

**Note:** If the check sum is not identical, check the connection of all the controllers, and retry the data base copy.

**12. Turn off the power of source and destination system controllers.**

## ■ PS-Data Operator Password Check

In case operators have forgotten their passwords, the administrator can check the passwords in the following procedure.

### ● Operation

**1. Turn off the power.**

**2. Turn on the power of system controller while holding down the button 4 and MON (ESC) button.**

“Admin Password” will appear on the LCD to enter the password.

```
PSD Password Check
Admin Password _____
```

**3. Enter the administrator password.**

The password entered will be displayed as “\*” marks.

```
PSD Password Check
Admin Password *****
```

**Notes:**

- The factory default is “650”.
- If the password entered is wrong, the LCD display will return to Step 2.

**4. Press the CAM (SET) button.**

If the password entered is correct, “User ID” and “Password” of Operator 1 will appear on the LCD while you are holding down the buttons.

```
No.01 User ID 650
Password 650
```

**5. To search a desired operator, rotate the JogDial.**

The user ID and password of Operator 1 to 16 will appear interchangeably.

**6. Turn off the power.**

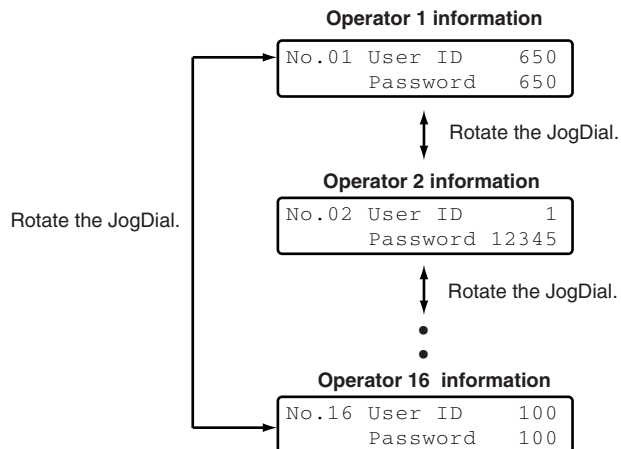

# BEFORE OPERATION

## ■ Power-on

Before operation, confirm the system composition. Depending on system composition, some functions may be unavailable.

1. Plug the supplied AC adapter into an AC 120 V outlet.
2. Insert the DC 9 V plug into the DC 9V Input Jack at the rear panel.

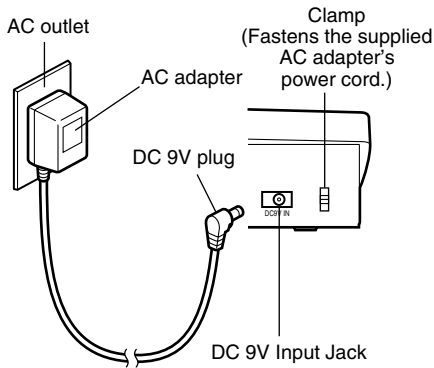

The power will be turned on. Then, the OPERATE indicator will light up, and the software version → controller number → login standby display will appear on the LCD.

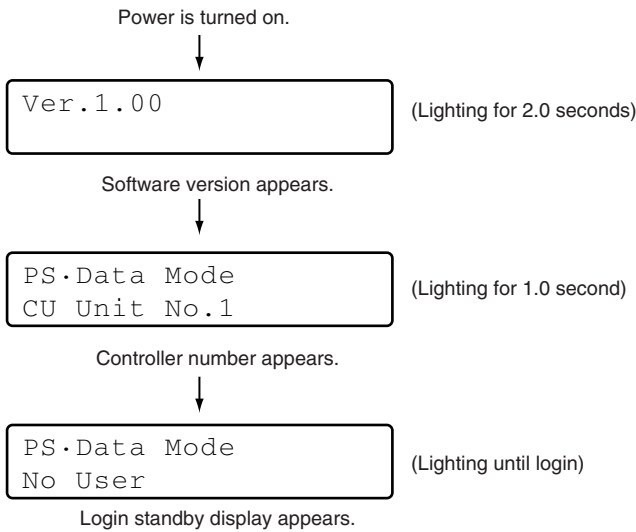

## ■ Power-off

After operation, power off the system controller as follows.

1. Log out from the system. (Refer to p. 30.)

2. Unplug the AC adapter from the AC outlet.

The power will be turned off. Then, the OPERATE indicator will go out.

### When leaving away from the system controller for a long time

Log out of the system and unplug the AC adapter from the AC outlet. If the AC adapter is kept plugged into the AC outlet, the adapter will consume electricity even after the DC 9 V plug is removed from the DC 9V Input Jack.

## ■ Basic Operation Flow

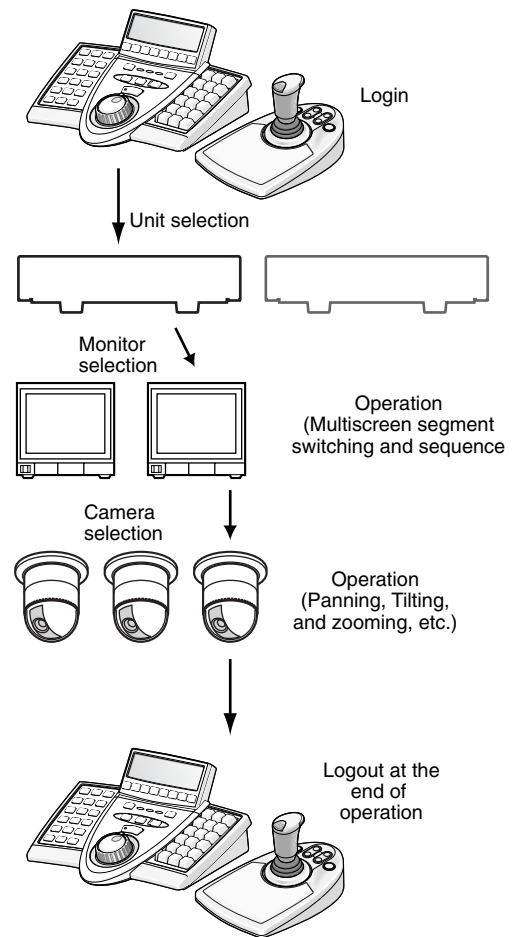
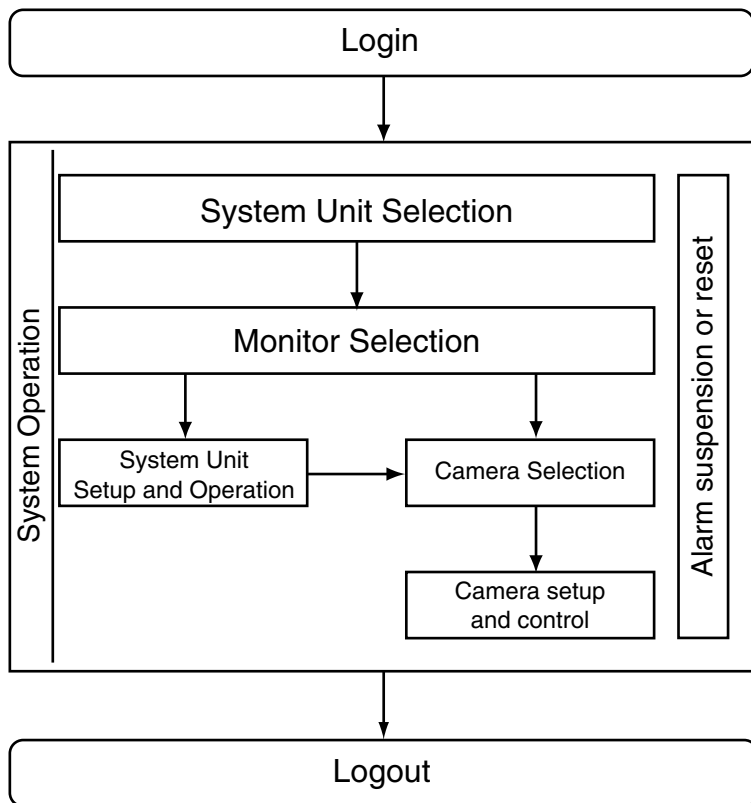

## ■ LCD/BUZZER Adjustment

You can perform the settings of LCD brightness, LCD contrast, alarm buzzer, or button buzzer as follows.

### 1. Press the ADJUST button to select a desired menu.

Every pressing the button will display the brightness setting menu → contrast setting menu → alarm buzzer setting menu → button buzzer setting menu interchangeably.

**Note:** If no adjustment has been performed for 5 seconds or more, these setting menus will automatically disappear and the LCD will return to the default status.

### 2. After adjustment, press the MON (ESC) or EXIT button.

The LCD display will return to the default status.

### ● Brightness Level Adjustment

You can change the brightness level by rotating the JogDial.

Adjust the LCD brightness level while watching the LCD.



**Note:** 1 (lowest) to 20 (highest) are available. The factory default is 14.

### ● Contrast Level Adjustment

You can change the contrast level by rotating the JogDial. Adjust the contrast level while watching the LCD.



**Note:** 1 (highest) to 20 (lowest) are available. The factory default is 9.

### ● Alarm Buzzer Setting

You can change the duration time of alarm buzzer sound by rotating the JogDial. Adjust the alarm buzzer setting while watching the LCD.



**Note:** OFF, 1s (second), 2s, 3s, 4s, ..., 30s, 40s, 50s, and 60s are available. The factory default is 2s.

## ● Button Buzzer Setting

You will perform the setting whether to activate a sound when a button is pressed. Select the desired parameter by rotating the JogDial.

Buzzer Operation ON

### Notes:

- OFF or ON is selectable. The factory default is ON.
- If set to ON, short buzzer will sound three times in the following occasions.  
(p. 15) Invalid, Prohibited  
(p. 62) Level 1 Fixed

## ■ Operation Start (Login)

Before starting operation, user authentication by the ID and password is required. (Refer to p. 62 for details on the setting of ID and password.)

### Notes:

- User authentication is skipped when the auto login is set to ON. (Refer to p. 30.)
- The factory default of operator information is as follows.
- If no operation has been performed for 5 seconds or more, the LCD display will return to the login standby display.

Operator No.	User ID	Password	Function level	Camera level
1	650	650	1	1
2	1	12345	1	1
3	100	100	2	1
4	101	101	3	1
5	102	102	3	1
6	103	103	3	1

1. Turn on the power. (Refer to p. 27 Power-on and Power-off.)
2. Wait until the login standby display appears.

PS·Data Mode  
No User

3. Press the CAM (SET) button. "User ID" entry form will appear on the LCD.

User ID            \_\_\_\_\_

4. Enter the ID number by pressing the numeric buttons. The user ID entered will appear on the LCD.

User ID            \_\_\_650

### Notes:

- To delete a character, press the CLEAR button.
- You can also enter your user ID without pressing the CAM (SET) button.

5. Press the CAM (SET) button. When the ID number is correct, "Password" entry form appears on the LCD.

User ID            650  
 Password            \_\_\_\_\_

6. Enter the password by pressing the numeric buttons. Then, press the CAM (SET) button.

User ID            650  
 Password            \_\_\_\*\*\*

### Notes:

- To delete a character, press the CLEAR button.
- The password will be displayed as \* marks.

7. When the password is correct, "Login OK" appears on the LCD. Then, the LCD changes to the operation display.

Login OK

Mon04 Cam128 Unit16  
 F1    F2    F3    F4

Mon04 Cam128 HD316  
 F1    F2    F3    F4

### Notes:

- The smallest monitor, camera, and unit numbers are displayed on the LCD.
- Three seconds after the unit number was determined, model number appears in place of unit number.
- When the ID or password is wrong, "Invalid" blinks on the LCD. Then, the LCD returns to the login standby display.

Invalid

PS·Data Mode  
No User

## ■ If You Have Forgotten the Login Password

Refer to the system administrator.

## ■ Operation Start (Auto Login)

When auto login is set to ON, operators can log into the system without entering their passwords. The LCD display after power-on becomes as follows. (Refer to p. 61 for details on the setting.)

1. When the power is turned on, "Auto Login" appears on the LCD for a second.

```
PS·Data Mode
Auto Login
```

2. The user ID of auto login user appear on the LCD. Then, the operator will log into the system automatically.

```
PS·Data Mode
User ID      =   650
```

```
Mon01 Cam128 Unit16
  F1   F2   F3   F4
```

```
Mon01 Cam128 HD316
  F1   F2   F3   F4
```

### Notes:

- This illustration is an example in which the operator number is "650".
- The smallest monitor, camera, and unit numbers are displayed on the LCD.
- Three seconds after the unit number was determined, model number appears in place of unit number.
- Due to security, the password is not displayed on the LCD.

## ■ Operation End (Logout)

You need to log out from the system:

- When finishing operation and turning off the power
- When changing an operator

1. During the login status, press the LOGOUT button while holding down the SHIFT button.
2. You will log out of the system, and "Logout" will appear on the LCD. Then, the LCD returns to the login standby display.

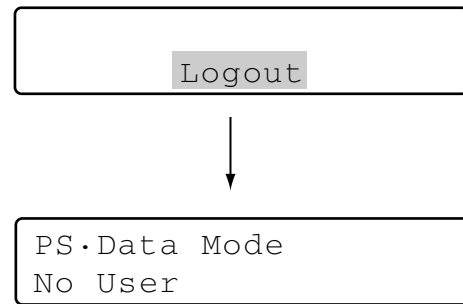

### Alarm sign after logout

If power is being supplied even after logout, the current system status will be continuously informed by "Alarm sign" and the ALM SUSPEND indicator. If an alarm is newly activated after logout, "Alarm" sign will blink. (The blinking will change to steady light when the alarm is automatically reset.)

# UNIT SELECTION

To control the system, you need to select a desired unit (system unit, recorder, monitor, or camera) at the beginning.

## System Unit Selection

**Notes:**

- In advance, you need to set the unit number for each system unit. (Refer to the operating instructions of system units.)
- 1 to 99 are available for the unit number.

1. Enter a unit number by pressing the numeric buttons. The entered number will appear on the LCD.

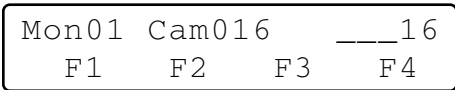

2. Press the RECORDER/UNIT button while holding down the SHIFT button. The system will become ready for control. Then, the monitor number, camera number, and system unit number will appear on the LCD.

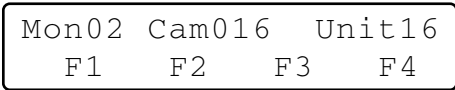

**Notes:**

- Three seconds after, model number will appear in place of unit number. To display the unit number again, hold down the RECORDER/UNIT.

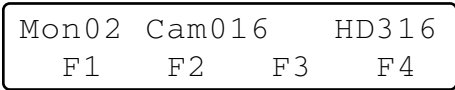

- If you have entered a wrong unit number, "Invalid" will appear on the LCD. Then, the LCD will return to the status before the system unit selection.

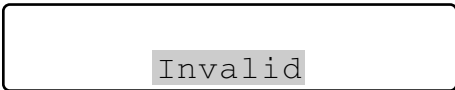

## Recorder Selection

**Notes:**

- In advance, you need to set HDD-unit maps. (Refer to p. 67 Associating Recorder Numbers with Unit Numbers.)
- In the factory default, Recorder 1 to 16 is associated with Unit 1 to 16.

1. Enter a recorder number by pressing numeric buttons. The entered number will appear on the LCD.

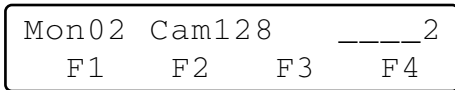

2. Press the RECORDER/UNIT button. The system will become ready for control, and the monitor number, camera number, and system unit number will appear on the LCD.

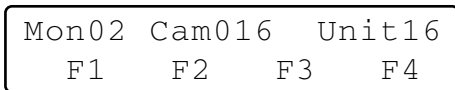

**Notes:**

- Three seconds after, model number will appear in place of unit number.

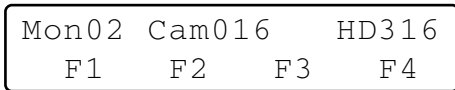

- If you have entered a wrong recorder number, "Invalid" will appear on the LCD. Then, the LCD will return to the status before the recording selection.

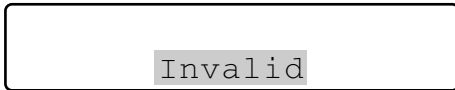

## ■ Monitor Selection

When two or more monitors are connected to a system unit, you can select a desired monitor.

When monitor selection is unavailable, “Mon- -“ appears on the LCD. The selected system unit does not support monitor selection.

1. Select a system unit (including a recorder) connected to a monitor you wish to control. (Refer to p. 31 System Unit Selection.)

```
Mon01 Cam016 HD316
  F1    F2    F3    F4
```

2. Select the desired monitor number by pressing the numeric buttons. The entered number will appear on the LCD.

```
Mon01 Cam016 ____16
  F1    F2    F3    F4
```

**Note:** Refer to the operating instructions of system unit for available monitor numbers.

3. Press the MON (ESC) button. The monitor number will appear on the LCD. The system will become ready for monitor control.

```
Mon02 Cam016 HD316
  F1    F2    F3    F4
```

**Note:** If you have entered a wrong monitor number, “Invalid” will appear on the LCD. Then, the LCD will return to the status before the monitor selection.

```
Mon02 Cam016 HD316
          Invalid
```

## ■ Camera Selection

When two or more cameras are connected to a system unit, you can select a desired camera. You will also perform camera selection when changing camera channels.

1. Select a system unit and monitor connected to a camera you wish to control. (Refer to p. 31 System Unit Selection and Monitor Selection in this page.)

```
Mon01 Cam001 HD316
  F1    F2    F3    F4
```

**Note:** If camera numbers are associated with unit numbers, you can skip system unit selection. (Refer to p. 66 Associating Camera Numbers with Unit Numbers.)

2. Select a camera number by pressing the numeric buttons. The entered number will appear on the LCD.

```
Mon01 Cam001 ____16
  F1    F2    F3    F4
```

### Notes:

- Refer to the operating instructions of system unit for available camera numbers.
- You can also select cameras by pressing the + or – button. When pressing the + button, the monitor will display the image of camera with the higher channel number. When pressing the – button, the monitor will display the image of camera with the lower channel number.

3. Press the CAM (SET) button. The system will become ready for control. Then, the camera number will appear on the LCD, and the image of selected camera will be displayed on the active monitor.

```
Mon01 Cam016 HD316
  F1    F2    F3    F4
```

**Note:** If you have entered a wrong camera number (other than 1 to 999), “Invalid” will appear on the LCD. Then, the LCD will return to the status before selecting the camera.

```
Mon01 Cam016 HD316
          Invalid
```

### Signs displayed on the LCD

“Seq”: This sign is displayed when a sequence is activated.

“Seq-P”: This sign is displayed when a sequence is paused.

“C-Pnnn\*”: This sign is displayed when a camera position is selected. (Camera position is the combination of camera number and preset position number.) \* nnn is a camera position number.



# SYSTEM UNIT CONTROL

The following are the procedures to control system units (including recorders).

## ■ Multiscreen Display

The following procedure is available when a selected system unit (for example, a hard disk recorder) has the multiscreen display function.

1. Select a system unit and monitor. (Refer to p. 31 System Unit Selection and p. 32 Monitor Selection.)
2. Do either of the following.
  - Press the MULTI SCREEN button.
  - Press the desired numeric buttons (refer to the diagram), then press the MULTI SCREEN button.

Images will be displayed in the specified multiscreen segment pattern on the monitor. Every pressing the MULTI SCREEN button can change the multiscreen segment pattern.

Numeric buttons	Multiscreen display pattern
0	4 segments
1	7 segments
2	9 segments
3	10 segments
4	13 segments
5	16 segments

**Note:** Available multiscreen segment patterns differ depending on system units. Refer to the operating instructions of system units.

## ■ Electronic Zooming

The following procedure is available when a selected system unit has the electronic zooming function.

1. Select a system unit, monitor, and camera. (Refer to p. 31 System Unit Selection, p. 32 Monitor Selection, and p. 32 Camera Selection)
2. Press the EL-ZOOM button. The camera image on the monitor will be zoomed. Every pressing the EL-ZOOM button can change the zooming rate.
3. To move the zoomed area, move the 3D joystick to desired directions. (Refer to the operating instructions of system unit.)

**Note:** Available zooming rates differ depending on system units. (Refer to the operating instructions of system units for details.)

## ■ Tour Sequence/Group Sequence

Sequence monitoring is the function to switch camera images automatically, according to the order registered in the system unit. The following procedure is available when a selected system unit has the tour or group sequence monitoring function.

**Note:** Before performing the procedure, the sequence setup of system unit is required.

1. Select a system unit and monitor. (Refer to p. 31 System Unit Selection and p. 32 Monitor Selection.)
2. Enter a desired sequence number.
3. To activate a tour sequence, press the TOUR SEQ/GROUP SEQ button.  
To activate a group sequence, press the TOUR SEQ/GROUP SEQ button while holding down the SHIFT button. The sequence will be activated, and "Seq" will appear on the monitor, in place of the camera number.

Mon02	Seq	HD316
F1	F2	F3 F4

### Notes:

- If you have skipped entering the sequence number in Step 2, Tour or Group Sequence 1 will be activated.
- If the selected recorder supports sequence pausing, you can pause the sequence by pressing the SEQ PAUSE/SEQ STOP button. During the sequence pause, "Seq-P" will appear on the LCD in place of "Seq".

3. To quit the sequence monitoring, press the SEQ PAUSE/SEQ STOP while holding down the SHIFT button. The monitor display will return to the spot mode.

**Note:** If the selected system unit does not support sequence stop, stop the sequence by selecting a camera or activating the multiscreen display. (Refer to p. 32 Camera Selection or Multiscreen Display in this page.)

## ■ On-screen Display (OSD) Control

You can toggle the OSD information (display parameters such as camera title, monitor number, and recorder number) on the active monitor screen.

1. Select a desired monitor. (Refer to p. 32 Monitor Selection.)
2. To toggle the OSD information, press the OSD button.

**Note:** OSD information differs depending on system units. Refer to the operating instructions of system units.

## ■ System Function Control

You can recall system functions (functions of system units) by pressing the corresponding function numbers. Refer to the operating instructions of system units for the association of function numbers and system functions.

Mon01	Cam001	_____	3
F1	F2	F3	F4

1. Select a system unit and monitor. (Refer to p. 31 System Unit Selection and p. 32 Monitor Selection.)
2. Enter a function number by pressing the numeric buttons.
3. Press the CAM FUNC/SYS FUNC button while holding down the SHIFT button.  
The associated system function will be activated.

**Note:** If you assign system functions to the joystick function buttons (A, B, and top buttons), you can recall system functions by pressing these buttons. Refer to p. 47 MENU FUNCTION DESCRIPTIONS for details.

# RECORDER CONTROL

From this system controller, you can control digital disk recorders supporting PS-Data. You will control a recorder in the status in which a recorder has been selected.

## Manual Recording

1. To start the recording, press the REC button.  
Recording will be started.



2. To stop the recording, press the REC button again for two seconds.

### Notes:

Refer to the operating instructions of recorder for the available recording modes and total recording time.

## Playback

1. Select a desired recorder.  
Refer to p. 31 Recorder Selection.
2. Select a camera whose picture you wish to play back.  
Refer to p. 32 Camera Selection.  
When camera selection is not necessary, skip to Step 3.

3. To start playback, press the PLAY/PAUSE button.  
The playback will be started.

**Note:** The playback start point differs depending on recorders. (Refer to the operating instructions of recorder.)

### Operations available during playback

**Pause:** Refer to p. 9 ㉔ Play/Pause button.

**Single frame skip (Forward or backward field advance):** Refer to p. 9 ㉔ JogDial.

**Fast forward or fast reverse (Fast-forward or rewind):** Refer to p.9 ㉔ Shuttle ring.

**Hold playback speed:** Refer to p. 10 ㉔ Shuttle hold button.

**Skip (WJ-HD300 and WJ-HD500 Series):** Refer to p. 9 ㉔ JogDial.

**Play the latest recorded image (WJ-HD300 Series only):** Refer to p. 9 ㉔ Go to last button.

**Multiscreen display:** Refer to p. 9 ㉔ Multiscreen selection button.

**Marking (WJ-HD300 Series only):** Refer to p. 9 ㉔ Mark button.

4. To stop playback, press the STOP button.  
The playback will be stopped.

## Search Playback

Recorders have search playback functions based on recording times or recording events. When searching playback images, you can activate these functions from this system controller.

### Notes:

- WJ-HD100 Series does not support search playback.
- WJ-HD300 Ver. 1.2 or later / WJ-HD200 Ver. 1.24 or later / WJ-HD220 supports search playback.

## How to Display Search Lists

1. Press the SEARCH/T&D SEARCH button. "Search Mode" menu will appear on the LCD, and a search list (date-and-time entry form, record list, or recording event list, etc.) will be displayed on an active monitor.

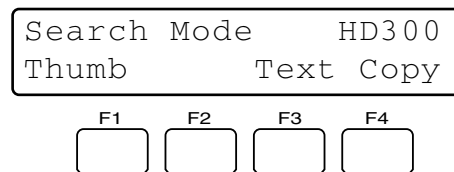

**Example: WJ-HD300 Series**

### Notes:

- Every pressing the SEARCH/T&D SEARCH button can change search list display. (For example, Record list → Thumbnail Display → Record List ...)
- The search list firstly displayed differs depending on recorders.

2. Perform operations while watching the active monitor.

**Note:** The operation details differ depending on recorders. Refer to pp. 36 to 38.

## Controls commonly available

### <Main unit>

#### Shuttle ring clockwise or counterclockwise:

Changes the search list display. (For example, Record list ↔ Thumbnail Display ↔ Record List ...)

**JogDial clockwise or counterclockwise:** Changes the selected parameter.

**Numeric buttons:** Enters numeric parameters.

**CAM (SET) button:** Determines the selected parameter or searching filter setting.

**MON (ESC) or EXIT button:** Closes the search list display.

**<3D joystick unit>**

**3D joystick upward (▲):** Moves the cursor up.

**3D joystick downward (▼):** Moves the cursor down.

**3D joystick to the left (◀):** Moves the cursor to the left.

**3D joystick to the right (▶):** Moves the cursor to the right.

**Zoom wheel controller to the right or left:** Changes the search list display. (For example, Record list ↔ Thumbnail Display ↔ Record List ...)

**Top button:** Determines the selected parameter or searching filter setting.

## ● Operation (WJ-HD300 Series)

If you press the SEARCH/T&D SEARCH button, the date-and-time entry form will appear on the monitor. The search list display will change as follows.

Date-and-time entry form → Recording event list → VMD search list → Marking list → Date-and-time entry form →...

**Note:** To quit search playback, press the MON (ESC) or EXIT button. Live image will be displayed again on the monitor.

The following are the details on LCD display patterns and function buttons.

### LCD display while the event list is displayed on the monitor

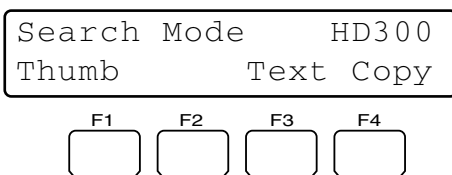

### LCD display while the thumbnail menu is displayed on the monitor

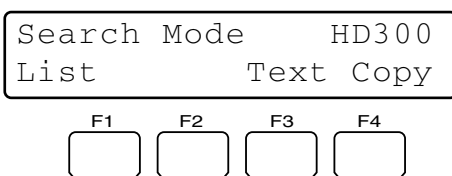

**Note:** While holding down the SHIFT button, the LCD display will become as follows.

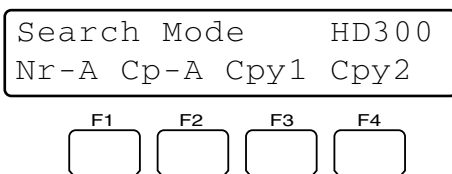

## Available buttons and functions

### F1 button: Thumb or List

Changes the monitor display between the recording event list window and thumbnail menu.

### F3 button: Text

Displays text information of selected event on the recording event list.

### F4 button: Copy

Displays the DATA COPY window while the recording event, VMD search, or marking list window is displayed.

### F1 button while holding down the SHFT button: Nr-A

Specifies the normal or event recording area for the playback media.

### F2 button while holding down the SHIFT button: Cp-A

Specifies the copy area for the playback media.

### F3 button while holding down the SHIFT button: Cpy1

This function is reserved for future use.

### F4 button while holding down the SHIFT button: Cpy2

This function is reserved for future use.

### Notes:

- The monitor display is not changed even if pressing the F1 button while the date-and-time entry form is displayed.
- To close the monitor display activated by the function buttons, press the MON (ESC) button.
- The DATA COPY window is not displayed while a thumbnail window is displayed.
- Refer to the operating instructions of recorder for details on each function.

### Example of searching filter display and settings

- Repeat pressing the SEARCH/T&D SEARCH button to display the recording event list window.

TIME&DATE	CAMERA	REC EVENT	TEXT	UNLOCK FILTER
TIME&DATE	CAM	REC EVT	TEXT	
▶ APR.25.03*12:34:56 AM	01ch	MANUAL	ABCDEFGHIJKLMNOP	
▶ APR.25.03*12:34:56 AM	01ch	MANUAL	ABCDEFGHIJKLMNOP	
▶ APR.25.03*12:34:56 AM	01ch	MANUAL	ABCDEFGHIJKLMNOP	
▶ APR.25.03*12:34:56 AM	01ch	MANUAL	ABCDEFGHIJKLMNOP	
▶ APR.25.03*12:34:56 AM	01ch	MANUAL	ABCDEFGHIJKLMNOP	
▶ APR.25.03*12:34:56 AM	01ch	MANUAL	ABCDEFGHIJKLMNOP	
▶ APR.25.03*12:34:56 AM	01ch	MANUAL	ABCDEFGHIJKLMNOP	
APR.25.03*12:34:56 AM → APR.25.03*12:34:56 AM				TOTAL 100
TIME&DATE • SEARCH • REC EVENT • SEARCH • VMD • SEARCH • MARK				

- To select "CAMERA" for the searching filter, move the 3D joystick to right or left.

TIME&DATE	CAMERA	REC EVENT	TEXT	UNLOCK FILTER
TIME&DATE	CAM	REC EVT	TEXT	
▶ APR.25.03*12:34:56 AM	01ch	MANUAL	ABCDEFGHIJKLMNOP	
▶ APR.25.03*12:34:56 AM	01ch	MANUAL	ABCDEFGHIJKLMNOP	
▶ APR.25.03*12:34:56 AM	01ch	MANUAL	ABCDEFGHIJKLMNOP	
▶ APR.25.03*12:34:56 AM	01ch	MANUAL	ABCDEFGHIJKLMNOP	
▶ APR.25.03*12:34:56 AM	01ch	MANUAL	ABCDEFGHIJKLMNOP	
▶ APR.25.03*12:34:56 AM	01ch	MANUAL	ABCDEFGHIJKLMNOP	
▶ APR.25.03*12:34:56 AM	01ch	MANUAL	ABCDEFGHIJKLMNOP	
APR.25.03*12:34:56 AM → APR.25.03*12:34:56 AM				TOTAL 100
TIME&DATE • SEARCH • REC EVENT • SEARCH • VMD • SEARCH • MARK				

- To determine the filter setting, press the CAM (SET) button of main unit or top button of 3D joystick unit. The searching filter window will appear on the active monitor, and the selected camera channels will be displayed on the window.

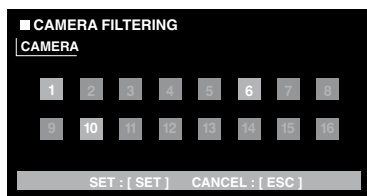

**Note:** When you press the MON (ESC) button, the searching filter window will be closed.

- To select a desired camera channel, move the 3D joystick to right of left.
- To change the filter setting, do either of the following.
  - Rotate the JogDial clockwise or counterclockwise.
  - Press the + or - button.
 The selected camera channels will turn to blue, and other channels will be displayed in gray.
- Press the CAM (SET) button of main unit or top button of 3D joystick unit. The associated recording event will be displayed on the monitor.

**Note:** To change the filter settings of two or more camera channels, repeat Step 5.

## ● Operation (WJ-HD500 Series)

If you press the SEARCH/T&D SEARCH button, the date-and-time entry form will appear on the monitor. The search list display will change as follows.

Record List → Thumbnail Display → Record List →...

**Note:** To quit search playback, press the MON (ESC) or EXIT button. Live image will be displayed again on the monitor.

The following are the details on LCD display patterns and function buttons.

### LCD display

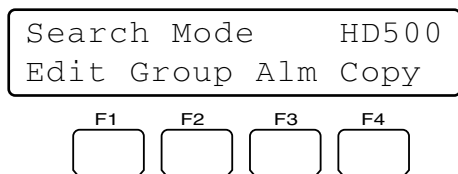

### Available buttons and functions

#### F1 button: Edit

You will press this button when editing the Search Editing Area on the Record List.

#### F2 button: Group

The selected group is switched by rotation.

#### F3 button: Alm

Only the Alarm and Emergency Record List will be displayed on the monitor.

#### F4 button: Copy

The selected recording images will be copied to an external recording device (DVD or CD-R).

#### F1 button while holding down the SHIFT button: Drive

Record List of external recording device will be displayed. The LCD display becomes as follows.

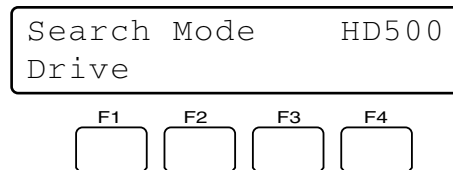

**Note:** Refer to the operating instructions of recorder for details on each function.

### Example of F1 button use

- Press the SEARCH/T&D SEARCH button. Record List will be displayed on the active monitor.

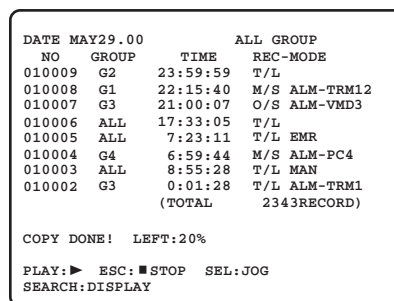

- Press the F1 button.

Search Editing Area will appear on the Record List.

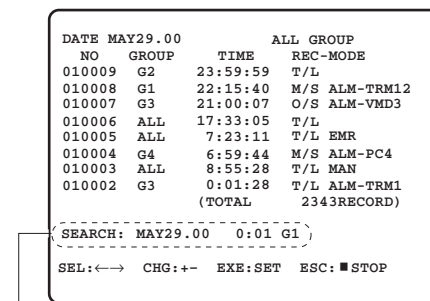

Search Editing Area

- Move the cursor to a position to be edited by performing either of the following.

- Move the 3D joystick controller to the right or left.
- Rotate the shuttle ring clockwise or counterclockwise.

- Enter the desired date and time by performing either of the following.
  - Rotate the JogDial clockwise or counterclockwise.
  - Press the + or – button.
- Repeat Step 3 and 4 to edit Search Editing Area.

DATE	MAY29.00	ALL	GROUP
NO	GROUP	TIME	REC-MODE
010009	G2	23:59:59	T/L
010008	G1	22:15:40	M/S ALM-TRM12
010007	G3	21:00:07	O/S ALM-VMD3
010006	ALL	17:33:05	T/L
010005	ALL	7:23:11	T/L EMR
010004	G4	6:59:44	M/S ALM-PC4
010003	ALL	8:55:28	T/L MAN
010002	G3	0:01:28	T/L ALM-TRM1
	(TOTAL	2343	RECORD)

SEARCH: MAY29.00 9:31 G1

SEL: ← → CHG: +- EXE: SET ESC: ■ STOP

- After editing, press the CAM (SET) button. The associated record will be displayed on the Record List.

## ● Operation (WJ-HD200 Series)

The following is the LCD display and operating procedure of search playback.

### LCD display

Search Mode HD200

### Operating procedure

- Press the SEARCH/T&D SEARCH button. The time & date search window will be displayed on the active monitor.

03-05-07 20:30:00  
TO SEARCH PUSH PLAY KEY

- Move the cursor to a position to be edited by performing either of the following.
  - Move the 3D joystick controller to the right or left.
  - Rotate the shuttle ring clockwise or counterclockwise.
- Enter the desired date and time by performing either of the following.
  - Rotate the JogDial clockwise or counterclockwise.
  - Press the + or – button.
- Press the PLAY/PAUSE button or CAM (SET) button. The specified playback image will be displayed on the monitor.

### Notes:

- To quit search playback, press the MON (ESC) or EXIT button. Live image will be displayed again on the monitor.
- You will use no function buttons for controlling the recorder.
- Image to be played back differs depending on recorders. (Refer to the operating instructions of recorder.)

## ■ Time & Date Search Playback

You can search playback images by entering a desired recording date and time.

**Note:** To cancel the entry, press the MON (ESC) or EXIT button. The LCD display will return to the normal status.

- Press the T & D SEARCH button while holding down the SHIFT button. The time-and-date entry form will appear on the LCD.

Mmm/DD/YYYY HH:MM 12  
Mar/17/2004 12:00 AM

**Note:** You can change the display pattern setting. (Refer to p. 60 Time & Date Search Display Pattern.)

- Move the cursor to a position to be edited by performing either of the following.
  - Move the 3D joystick controller to the right or left.
  - Rotate the shuttle ring clockwise or counterclockwise.

Mmm/DD/YYYY HH:MM 12  
Mar/16/2004 01:32 PM

- Enter the desired date and time by performing either of the following.
  - Rotate the JogDial clockwise or counterclockwise.
  - Press the numeric buttons.
- Press the PLAY/PAUSE or CAM (SET) button. The image on the specified date and time will be played back on the active monitor. After the image has been played back, the LCD will return to the default status.

### When using WJ-HD500 Series

Group selection is required after Step 3. Perform as follows.

- Press the PLAY/PAUSE or CAM (SET) button. "Group Select" menu will appear on the LCD.

HD500 Index Search  
Group Select = All-G

2. Select a desired group to play back by rotating the JogDial.
3. Press the PLAY/PAUSE or CAM (SET) button again.  
The image on the specified date and time will be played back on the active monitor.

**Note:** Image to be played back differ depending on recorders. (Refer to the operating instructions of recorder.)

## ■ Other Available Functions

Depending on recorders, the following functions are available.

- Disk selection (WJ-HD300 Series only) (p. 57)
- A - B repeat playback setting (WJ-HD300 Series only) (pp. 57 and 72)
- Filtering ON/OFF (WJ-HD300 Series only) (p. 58)
- Displaying camera and playback image (WJ-HD500 Series only) (p. 58)
- Recorded-image copy (WJ-HD500 Series only) (p. 72)
- Alarm search (WJ-HD200 Series / WJ-HD100 Series) (p. 73)

# CAMERA CONTROL

You can control cameras from this system controller.

## ■ Camera Panning/Tilting Control

The following procedure is available when panning/tilting heads or combination cameras are connected to system units.

1. Select a system unit, monitor, and desired camera. (Refer to p. 31 System Unit Selection, p. 32 Monitor Selection, and p. 32 Camera Selection.)
2. Move the 3D joystick to desired directions. The selected camera will pan and tilt. If you move the 3D joystick widely, you can pan and tilt the camera faster.

**Note:** Panning/tilting speed differs depending on cameras.

## ■ Zooming Control

The following procedure is available when a motorized zoom lens is attached to a camera.

1. Select a system unit, monitor, and desired camera. (Refer to p. 31 System Unit Selection, p. 32 Monitor Selection, and p. 32 Camera Selection.)
2. Move the zoom wheel controller (located at the top of 3D joystick).
  - Turning the zoom wheel controller to the right will zoom the image. (The zooming level will go up.)
  - Turning the controller to the left will widen the scene. (The zooming level will go down.)

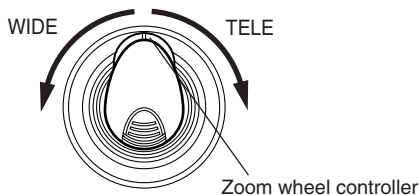

**Note:** Available zooming rates differ depending on the motorized zoom lens.

## ■ Lens Iris Control

The following procedure is available when a selected camera has an adjustable lens iris.

1. Select a system unit, monitor, and desired camera. (Refer to p. 31 System Unit Selection, p. 32 Monitor Selection, and p. 32 Camera Selection.)
2. Adjust the lens iris by pressing the IRIS OPEN or CLOSE button of 3D joystick unit.
  - Pressing the IRIS OPEN will open the lens iris.
  - Pressing the IRIS CLOSE will close the lens iris.

### To reset the lens iris to the default status

Press the A button of 3D joystick unit.

The lens iris will be adjusted automatically.

**Note:** As the factory default, iris reset has been assigned to the A button. You can assign iris reset to the function buttons (F1 to F4/F5 to F8) or joystick function buttons (A, B, and top buttons). (Refer to pp. 52 and 53 for assignment.)

## ■ Lens Focus Control

The following procedure is available when a selected camera has a lens whose focus is adjustable.

1. Select a system unit, monitor, and desired camera. (Refer to p. 31 System Unit Selection, p. 32 Monitor Selection, and p. 32 Camera Selection.)
2. Adjust the lens focus by pressing the FOCUS NEAR and FAR buttons of 3D joystick unit.
  - Pressing the FOCUS NEAR will bring the focus nearer to the object.
  - Pressing the FOCUS FAR will bring the focus farther from the object.

### To adjust the lens focus automatically

Press the B button of main unit or top button of 3D joystick unit. The lens focus will be adjusted automatically for the object displayed when you pressed the button.

**Note:** As the factory default, auto focus has been assigned to the B button and top button. You can assign auto focus to the function buttons (F1 to F4/F5 to F8) or joystick function buttons (A, B, and top buttons). (Refer to pp. 52 and 53 for assignment.)



## ■ Preset Position Control

Preset position is the function to register camera monitoring positions (preset positions) associated with position numbers. By entering the position numbers, you can move cameras to the preset positions.

**Note:** To activate this function, you need to register the preset positions of combination camera.

1. Select a system unit, monitor, and desired camera. (Refer to p. 31 System Unit Selection, p. 32 Monitor Selection, and p. 32 Camera Selection.)
2. Enter a preset position number by pressing the numeric buttons. The entered number will appear on the LCD.

```
Mon02 Cam001  ____3
  F1   F2   F3   F4
```

3. Press the PRESET/PGM PRESET button. The camera will move to the registered preset position, and the preset position image will be displayed on an active monitor.

```
Mon02 Cam001  Pre03
  F1   F2   F3   F4
```

### To register preset positions

1. Move the camera to a desired position by moving the 3D joystick.
2. Enter a preset position number you wish to register by pressing the numeric buttons. The entered number will appear on the LCD.

```
Mon01 Cam001  ___12
  F1   F2   F3   F4
```

3. Press the PRESET/PGM PRESET button while holding down the SHIFT button. The preset position will be registered, and “Memory” will appear on the LCD.

```
Mon01 Cam001  Pre12
           Memory
```

**Note:** If the registration have failed, “Invalid” will appear on the LCD. (Example: When the selected camera does not support preset position control)

```
Mon01 Cam001  Pre12
           Invalid
```

## ■ Home Position Control

Home position is the default preset position. You can move the camera to the home position only by pressing the PRESET/PGM PRESET button.

**Note:** To activate this function, you need to register the home position of combination camera. (Refer to the operating instructions of combination camera.)

1. Select a system unit, monitor, and desired camera. (Refer to p. 31 System Unit Selection, p. 32 Monitor Selection, and p. 32 Camera Selection.)
2. Press the PRESET/PGM PRESET button. The camera will move to the registered home position, and the home position image will be displayed on an active monitor.

**Note:** You can also move the camera to the home position by pressing the button 0, and then the PRESET/PGM PRESET button.

## ■ Camera Function Control

You can recall the camera functions of combination cameras by entering the function number from this system controller. Refer to the operating instructions of combination camera for the association of camera numbers and functions.

1. Select a desired combination camera. (Refer to p. 32 Camera Selection.)
2. Enter a camera function number by pressing the numeric buttons. The entered number will appear on the LCD.

```
Mon01 Cam001  ____3
  F1   F2   F3   F4
```

3. Press the CAM FUNC/SYS FUNC button. The associated camera function will be activated.

**Note:** If you assign camera functions to the joystick function buttons (A, B, and top buttons), you can recall the camera functions by pressing these buttons. Refer to p. 47 MENU FUNCTION DESCRIPTIONS for details.

## ■ Camera Position Control

Camera position is the association of camera numbers and preset position numbers. Up to 1 000 camera positions are registrable in the system, and you can move a desired camera to a desired preset position only by entering a camera position.

**Note:** To activate this function, preset positions and camera positions need to be registered. (Refer to p. 41 To register preset positions and p. 65 Camera Position Registration or Clearing.)

1. Select a system unit and monitor. (Refer to p. 31 System Unit Selection and p. 32 Monitor Selection.)
2. Enter a camera position number by pressing the numeric buttons. The entered number will appear on the LCD.

Mon01	Cam001	___11	
F1	F2	F3	F4

3. Press the CAM POSI button.  
The registered camera and preset position will be selected, and the camera position image will be displayed on the active monitor.

Mon01	C-P011	HD316	
F1	F2	F3	F4

## ■ Camera Selection Recall

Every time you select a camera or camera position, this system controller memorizes up to 10 steps of camera selection. You can recall these operations in order or reverse order. In the following procedure, you can track back the camera images formerly displayed.

**Note:** After power-off or system unit selection, the memorized camera operations will be cleared.

In the following example, Camera 1 → 3 → 128 has been selected.

1. Press the – button while holding down the HISTORY button. The camera image formerly selected will be displayed on an active monitor. (Camera 128 → 3)

**Note:** To recall camera images more formerly selected one by one, repeat pressing the – button while holding down the HISTORY button. (You can recall up to 10 camera images.)

Mon02	Cam128	HD316	
F1	F2	F3	F4



Mon02	Cam003	HD316	
F1	F2	F3	F4



Mon02	Cam001	HD316	
F1	F2	F3	F4

2. To return to the camera image more recently selected, press the + button while holding down the HISTORY button. The camera image more recently selected will be displayed on the monitor. (Camera 1 → 3 → 128)

Mon02	Cam001	HD316	
F1	F2	F3	F4



Mon02	Cam003	HD316	
F1	F2	F3	F4



Mon02	Cam128	HD316	
F1	F2	F3	F4

**Note:** To return to the camera images more recently selected one by one, repeat pressing the + button while holding down the HISTORY button.

## ■ Wiper Control

The following procedure is available when a selected camera (housing) is equipped with a wiper.

1. Select a system unit, monitor, and desired camera. (Refer to p. 31 System Unit Selection, p. 32 Monitor Selection, and p. 32 Camera Selection.)
2. Keep pressing the WIPER button.  
The wiper will be activated while this button is being pressed.

## ■ Defroster Control

The following procedure is available when a selected camera (housing) is equipped with a defroster.

1. Select a system unit, monitor, and desired camera. (Refer to p. 31 System Unit Selection, p. 32 Monitor Selection, and p. 32 Camera Selection.)
2. Press the DEF ON/OFF button.  
The defroster will be activated.  
  
**Note:** The defroster will be automatically deactivated after the specified time.
3. To deactivate the defroster, press the DEF ON/OFF button while holding down the SHIFT button.

## ■ Auxiliary Control

You can control one or two auxiliary control devices. The following procedure is available when an auxiliary control device, such as Receiver WV-RC150, is connected to a system unit.

**Note:** The operation procedure differs depending on the mode setting (=latch or momentary mode) of auxiliary control device.

### ● Operating Procedure (Latch mode)

1. Select a system unit, monitor, and camera an auxiliary control device is connected to. (Refer to p. 31 System Unit Selection, p. 32 Monitor Selection, and p. 32 Camera Selection.)
2. Press the AUX 1 ON/OFF or AUX 2 ON/OFF button.  
The auxiliary control device, associated by the installation wiring, will be activated.
3. To quit the auxiliary control, press the AUX 1 ON/OFF or AUX 2 ON/OFF button while holding down the SHIFT button.

### ● Operating Procedure (Momentary mode)

1. Select a system unit, monitor, and camera an auxiliary control device is connected to. (Refer to p. 31 System Unit Selection, p. 32 Monitor Selection, and p. 32 Camera Selection.)
2. Keep pressing the AUX 1 ON/OFF or AUX 2 ON/OFF button.  
The auxiliary control device, associated by the installation wiring, will be activated while this button is being pressed.

## ■ Other Functions

You can control the following functions by pressing the function buttons (F1 to F8). Refer to p. 55 MENU FUNCTION DETAILS.

- Camera setup (p. 55)
- Auto mode (p. 55)
- BW mode (p. 55)
- Patrol Learn (p. 56)
- Auto pan setup and activation (p. 57)
- Camera cleaning (p. 60)
- Camera function (p. 69)
- Auto pan (p. 70)
- Camera sequence (p. 70)
- Camera sort (p. 70)
- Patrol play (p. 70)
- Home position (p. 71)
- Auto focus (p. 71)
- Iris reset (p. 71)
- Camera +1 (p. 71)
- Camera -1 (p. 72)

# ALARM CONTROL

## ■ System Controller Behavior during the Alarm Mode

When an alarm signal is input to cameras or system units, this system controller is notified that an alarm has been activated. Then, the ALARM indicator will blink. During the alarm mode, "Alarm" sign will blink on the LCD, and the camera number is displayed as "-- --".

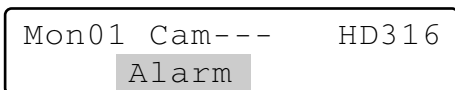

When an alarm is automatically canceled (=alarm auto reset mode), "Alarm" sign changes from blinking to steady light, and the LCD display returns to the normal status.

## ■ Alarm Reset

You can cancel the alarm mode ("Alarm" sign is blinking.) or alarm auto reset mode (The ALARM indicator is lighting.). The alarm inputs to all the system units will be reset all together.

Press ALM RESET/ALM ALL RESET button.

The alarm mode or alarm auto reset mode of all the system units will be cancelled, and the ALARM indicator will go out.

### Notes:

- Alarm behaviors differ depending on connected system units. Refer to the operating instructions of system units.
- You cannot cancel the alarm mode or alarm auto reset mode of each system unit one by one.

## ■ Alarm Suspension

You can temporarily stop alarm inputs to all the system units in the following procedure.

1. Press the ALARM/ALM SUSPEND button while holding down the SHIFT button.  
The alarm inputs will be suspended and the ALM SUSPEND indicator will light up.
2. To cancel the alarm suspension mode, press ALARM/ALM SUSPEND button again while holding down the SHIFT button. The alarm suspension mode will be canceled, and the ALM SUSPEND indicator will go out.

**Note:** You cannot suspend each alarm input one by one. The alarm inputs to all the system units will be suspended all together.

## ■ Alarm History Search

To play back a desired alarm image, the alarm history table of selected system unit can be displayed. The following procedure is available when the selected system unit can display the alarm history table.

**Note:** WJ-HD300 Series does not support alarm history search.

## ● How to Display Alarm History Tables

1. Press the ALM RECALL button.  
"Alarm Recall" sign will appear on the LCD, and the alarm history table will be displayed on an active monitor.

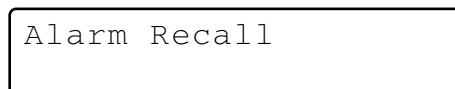

2. Perform operations while watching the active monitor.

**Note:** The operation details differ depending on recorders. Refer to pp. 45 to 46.

## Controls commonly available

### <Main unit>

#### Shuttle ring clockwise or counterclockwise:

- Changes the search list display. (For example, Record list ↔ Thumbnail Display ↔ Record List ...)
- Moves the cursor. (Available for WJ-HD500 or WJ-HD200 Series)

#### JogDial clockwise or counterclockwise:

- Moves the cursor.
- Changes the selected parameter. (Available for WJ-HD500 or WJ-HD200 Series)

**+ button:** Increases a numeric value.

**- button:** Decreases a numeric value.

**Numeric buttons:** Enters numeric parameters.

**CAM (SET) button:** Determines the selected parameter.

**MON (ESC) or EXIT button:** Closes the search list display.

**<Joystick unit>**

- 3D joystick upward (▲):** Moves the cursor up.
- 3D joystick downward (▼):** Moves the cursor down.
- 3D joystick to the left (◀):** Moves the cursor to the left.
- 3D joystick to the right (▶):** Moves the cursor to the right.

**Zoom wheel controller to the right or left:** Changes the search list display. (For example, Record list ↔ Thumbnail Display ↔ Record List ...)

**Top button:** Determines the selected parameter.

**Note:** Depending on recorder types, you can press the function buttons (F1 to F8) to activate the search function. The following are the details on LCD display patterns and function buttons of WJ-HD500, WJ-HD300, and WJ-HD100 Series recorders.

**● Operation (WJ-HD500 Series)**

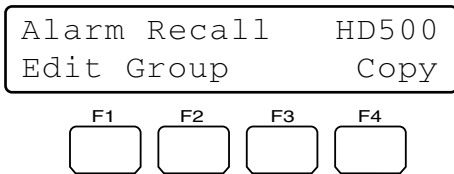

**Available buttons and functions**

**F1 button: Edit**

You will press this button when editing the Search Editing Area on the Record List.

**F2 button: Group**

The selected group is switched by rotation.

**F4 button: Copy**

The selected recording images will be copied to a external recording device (DVD or CD-R).

**Note:** Refer to the operating instructions of recorder for details on each function.

**Example of F1 button use**

1. Display the Alarm and Emergency Record List on the active monitor. (Refer to Step 1 in p. 44 Alarm History Search.)

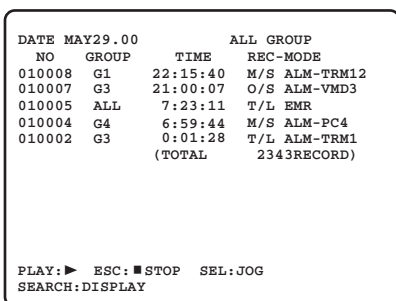

2. Press the F1 button.  
Search Editing Area will appear on the Record List.

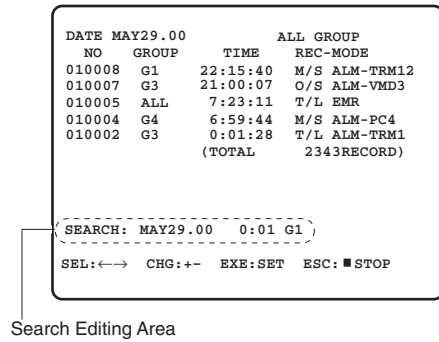

3. Move the cursor to a position to be edited by performing either of the following.
  - Move the 3D joystick controller to the right or left.
  - Rotate the shuttle ring clockwise or counterclockwise.
4. Enter the desired date and time by performing either of the following.
  - Rotate the JogDial clockwise or counterclockwise.
  - Press the + or - button.
5. Repeat Step 3 and 4 to edit Search Editing Area.

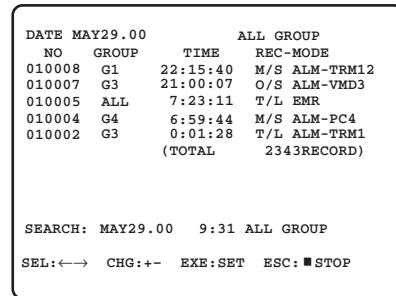

6. After editing, press the CAM (SET) button.  
The associated record will be displayed on the Record List.
7. To close the Alarm and Emergency Record List, press the ALM RECALL, EXIT, or MON (ESC) button.

## ● Operation (WJ-HD200 Series)

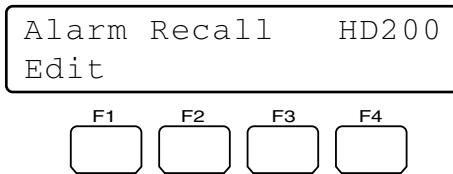

**Note:** WJ-HD200 Ver. 1.24 later or WJ-HD220 supports alarm history search. (Refer to the operating instructions of recorder.)

### Available buttons and functions

#### F1 button: Edit

You will press this button when editing the Search Editing Area on the ALARM RECALL window.

**Note:** Refer to the operating instructions of recorder for details.

### Example of F1 button use

1. Press the ALM RECALL button. The ALARM RECALL window will be displayed on the active monitor.

ALARM RECALL YEAR03			
NO.	DATE	TIME	ALM
2000	JUN14	20:30:00	T1
1999	JUN14	15:30:12	T3
1998	JUN14	12:15:04	T4
1997	JUN14	12:15:02	V8
1996	JUN14	10:07:05	V2
1995	JUN14	10:07:04	T2
1994	JUN14	10:06:55	T6
1993	JUN14	09:58:32	V5
(TOTAL 2000EVENTS)			
TO SEARCH PUSH T&D KEY			

2. Press the F1 button. Search Editing Area will appear on the ALARM RECALL window.

ALARM RECALL YEAR03			
NO.	DATE	TIME	ALM
2000	JUN14	20:30:00	T1
1999	JUN14	15:30:12	T3
1998	JUN14	12:15:04	T4
1997	JUN14	12:15:02	V8
1996	JUN14	10:07:05	V2
1995	JUN14	10:07:04	T2
1994	JUN14	10:06:55	T6
1993	JUN14	09:58:32	V5
(TOTAL 2000EVENTS)			
SEARCH JUN14.03 12:00			

Search Editing Area

3. Move the cursor to a position to be edited by performing either of the following.
  - Move the 3D joystick controller to the right or left.
  - Rotate the shuttle ring clockwise or counterclockwise.

4. Enter the desired date and time by performing either of the following.
  - Rotate the JogDial clockwise or counterclockwise.
  - Press the + or – button.
5. Repeat Step 3 and 4 to edit Search Editing Area.
6. Press the CAM (SET) button. The specified playback image will be displayed on the monitor.
7. To close the ALARM RECALL window, press the ALM RECALL, EXIT, or MON (ESC) button.

## ● Operation (WJ-HD100 Series)

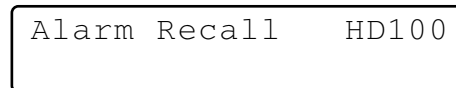

1. Press the ALM RECALL button. The ALARM RECALL window will be displayed on the active monitor.

ALARM RECALL 1 OF 10			
NO	DATE	TIME	ALM
99	JUN 9.00	00:00:00	* T
98	JUN 1.00	02:34:56	T
97	JUN 1.00	01:10:01	* V
96	MAY31.00	23:34:45	V
95	MAY30.00	02:00:20	* T
94	MAY14.00	05:30:31	* T
93	MAY 7.00	23:00:59	T
92	MAY 6.00	22:05:50	V
91	APR14.00	23:00:59	* T
90	APR14.00	16:06:34	* V

2. Move the cursor to a position to be edited by performing either of the following.
  - Move the 3D joystick controller to the right or left.
  - Rotate the JogDial clockwise or counterclockwise.
3. Enter the desired date and time by performing either of the following.
  - Rotate the JogDial clockwise or counterclockwise.
  - Press the + or – button.
4. Press the CAM (SET) button. The specified playback image will be displayed on the monitor.
5. To close the ALARM RECALL window, press the ALM RECALL, EXIT, or MON (ESC) button.

#### Notes:

- You will use no function buttons for controlling the recorder.
- Image to be played back differs depending on recorders. (Refer to the operating instructions of recorder.)

# MENU FUNCTION DESCRIPTIONS

You can assign frequently-used menu functions (system functions and camera functions, etc.) to the F1 to F8 button of system controller. (=Button function) In addition, you can also assign the menu functions to the A, B and top buttons of 3D joystick unit. (=Joystick button function) Only by pressing an associated button, you can recall the assigned button functions and joystick functions.

**Note:** For details, refer to p. 52 To Assign Menu Functions to Function Buttons or p. 53 To Assign Menu Functions to Joystick Function Buttons.

## Menu Flow

When you press the MENU button during normal operation, menu functions are displayed on the LCD. The menu functions are classified according to the function types (camera functions, recorder functions, and system functions, etc.) (Refer to p. 48 Menu Function Categories.)

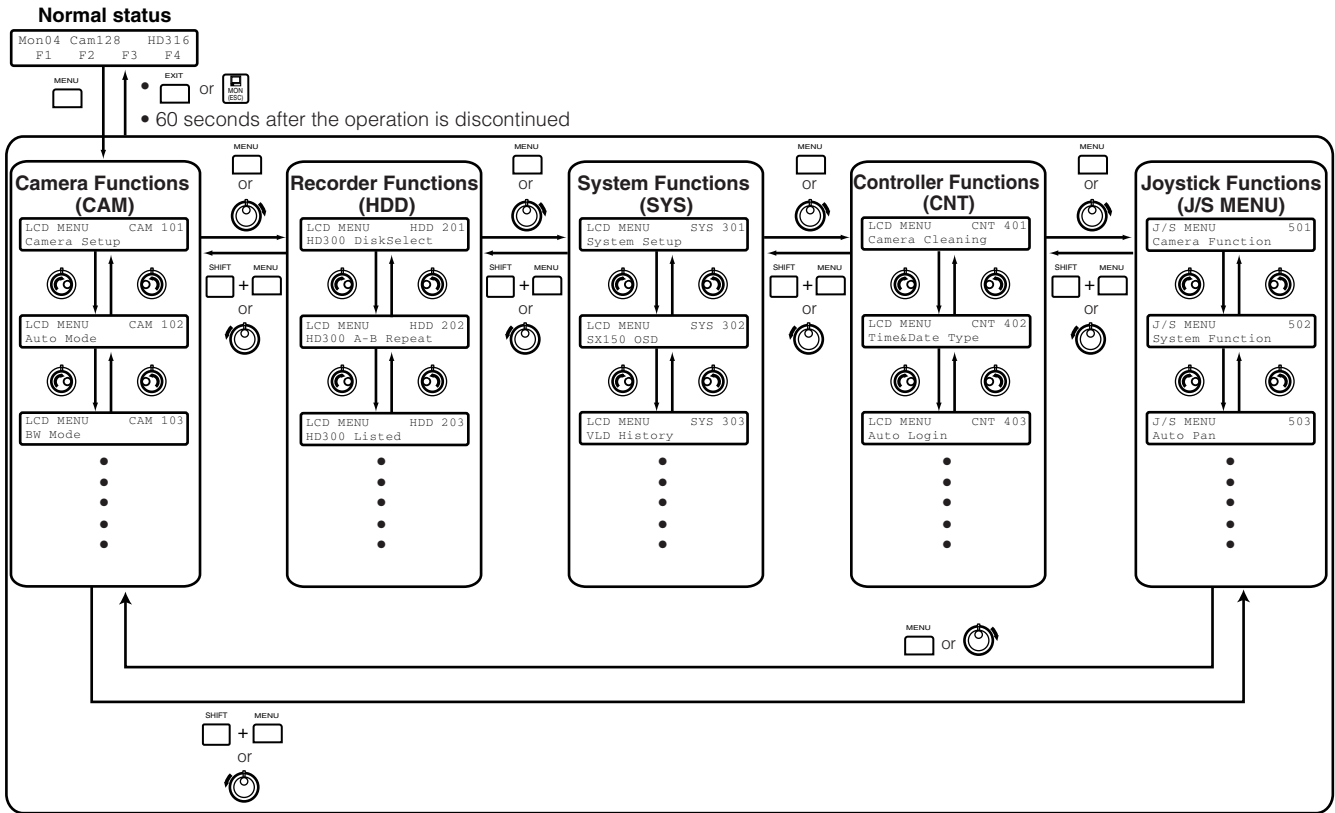

## ■ Menu Function Categories

Menu functions are classified in the following categories. Select a desired function for assignment or operation.

### ● Camera Functions (CAM)

#### Camera Setup

```
LCD MENU      CAM 101
Camera Setup
```

- This function displays or closes the camera setup menu for system settings.
- You will change camera settings.

#### Auto Mode

```
LCD MENU      CAM 102
Auto Mode
```

You will select and activate one of the auto mode functions of camera: sequence, sort, auto pan and patrol.

#### BW Mode

```
LCD MENU      CAM 103
BW Mode
```

You will select and activate one of the color modes: MANUAL ON, MANUAL OFF, AUTO 1, and AUTO 2.

**Note:** Refer to the operating instructions of camera for details on the BW mode.

#### Patrol Learn

```
LCD MENU      CAM 104
Patrol Learn
```

You will perform the patrol learn setting of camera.

#### Auto Pan Setup

```
LCD MENU      CAM 105
Auto Pan Setup
```

You will perform the auto pan setting of camera.

**Note:** Refer to the operating instructions of camera for details on the auto pan function.

### ● Recorder Functions (HDD)

#### HD300 Disk Select (WJ-HD300 Series only)

```
LCD MENU      HDD 201
HD300 DiskSelect
```

You will select the built-in hard disk or an external recording devices for playback by WJ-HD300 Series.

#### HD300 A-B Repeat (WJ-HD300 Series only)

```
LCD MENU      HDD 202
HD300 A-B Repeat
```

- You will set the start and end points of A – B repeat playback of WJ-HD300 Series.
- You will cancel A – B repeat playback of WJ-HD300 Series.

#### HD300 Listed (WJ-HD300 Series only)

```
LCD MENU      HDD 203
HD300 Listed
```

You will cancel, recover, or temporarily cancel the searching filter of WJ-HD300 Series.

#### HD500 V-Multi (WJ-HD500 Series only)

```
LCD MENU      HDD 204
HD500 V-Multi
```

You will select a playback picture to display on the upper left segment of the multiscreen monitor displaying live images.



## ● System Functions (SYS)

### System Setup

```
LCD MENU      SYS 301
System Setup
```

You will open the setup menu of system unit and change the settings.

### SX150 OSD (WJ-SX150 Series only)

```
LCD MENU      SYS 302
SX150 OSD
```

This function is reserved for future use.

### VLD History

```
LCD MENU      SYS 303
VLD History
```

This function is reserved for future use.

### Mux VCR/CAM (Available if Video Multiplexer WJ-FS416 or Multiplexer Board WJ-SXB151 is Used in the System)

```
LCD MENU      SYS 304
Mux VCR/CAM
```

You can activate either VCR playback or camera picture display on an active monitor.

### Mux Still (Available if Video Multiplexer WJ-FS416 or Multiplexer Board WJ-SXB151 is Used in the System)

```
LCD MENU      SYS 305
Mux Still
```

You can activate either still or moving mode for display on the multiscreen monitor.

## ● Controller

### Camera Cleaning

```
LCD MENU      CNT 401
Camera Cleaning
```

You will select the first and last camera channel to perform camera cleaning.

### Time & Date Type

```
LCD MENU      CNT 402
Time&Date Type
```

You will set the time and date display pattern of time-and-date entry form.

### Auto Login

```
LCD MENU      CNT 403
Auto Login
```

You will set operators who can log into the system automatically.

### Operator Setup

```
LCD MENU      CNT 404
Operator Setup
```

- You will register a new operator.
- You will change parameters of registered operators.

### Function Level

```
LCD MENU      CNT 405
Function Level
```

You will change the function levels of operators.

### Camera Level

```
LCD MENU      CNT 406
Camera Level
```

You will change the camera control levels of operators.

### Cam Posi Map

```
LCD MENU      CNT 407
Cam Posi Map
```

You will register camera positions (the association of camera numbers and preset position numbers).

## Cam-Unit Map

LCD MENU	CNT 408
Cam-Unit Map	

You will register cam-unit maps (the association of camera numbers and unit numbers).

## HDD-Unit Map

LCD MENU	CNT 409
HDD-Unit Map	

You will register HDD-unit maps (the association of recorder numbers and unit numbers).

## LCD Title

LCD MENU	CNT 410
LCD Title	

You will edit the function names of F1 to F8, which are displayed on the LCD.

## ● Joystick Button Functions (J/S MENU)

### Camera Function

J/S MENU	501
Camera Function	

A camera function will be activated.

### System Function

J/S MENU	502
System Function	

A system function will be activated.

### Auto Pan

J/S MENU	503
Auto Pan	

The auto pan function of selected camera will be activated.

## Camera Sequence

J/S MENU	504
Camera Sequence	

The camera sequence function of selected camera will be activated.

## Camera Sort

J/S MENU	505
Camera Sort	

The camera sort function of selected camera will be activated.

## Patrol Play

J/S MENU	506
Patrol Play	

The patrol function of selected camera will be activated.

## Home Position

J/S MENU	507
Home Position	

The selected camera will move to the home position.

## Auto Focus

J/S MENU	508
Auto Focus	

The "Auto Focus" function of selected camera will be activated.

## Iris Reset

J/S MENU	509
Iris Reset	

The lens iris of selected camera will be automatically reset to the factory default.

## Camera +1

J/S MENU	510
Camera +1	

The image of camera with the higher channel number will be displayed.

## Camera -1

J/S MENU	511
Camera -1	

The image of camera with the lower channel number will be displayed.

## HD300 A-B Repeat (WJ-HD300 Series Only)

J/S MENU	512
HD300 A-B Repeat	

- You will set the start and end points of A – B repeat playback of WJ-HD300 Series.
- You will cancel A – B repeat playback of WJ-HD300 Series.

## HD500 Copy (WJ-HD500 Series Only)

J/S MENU	513
HD500 Copy	

Recorded images will be copied from the built-in hard disk of recorder to external recording devices.

## HD200 Alarm Search (WJ-HD200 Series Only)

J/S MENU	514
HD200 Alm Search	

The alarm search function of recorder will be activated.

## Multiscreen Display

J/S MENU	515
Multi 4-Seg	

J/S MENU	516
Multi 7-Seg	

J/S MENU	517
Multi 9-Seg	

J/S MENU	518
Multi 10-Seg	

J/S MENU	519
Multi 13-Seg	

J/S MENU	520
Multi 16-Seg	

The screen of monitor connected to the selected system unit will be divided in multiscreen segments.

**Note:** Available multiscreen segment patterns differ depending on system units. Refer to the operating instructions of system units.

## To Recall Menu Functions

You can recall menu functions as follows.

1. Select a system unit for which you wish to recall a function. (Refer to p. 31 System Unit Selection, p. 31 Recorder Selection, p. 32 Monitor Selection, or p. 32 Camera Selection.)

Mon01	Cam016	HD316	
F1	F2	F3	F4

**Note:** You can skip Step 2 and 3 if you know what function to recall. In this case, enter a function number, and press the MENU button. Then, go to Step 4.

2. Press the MENU button.  
“Camera Setup” main menu will appear on the LCD.

LCD MENU	CAM 101
Camera Setup	

3. Select a desired function.  
Select a category (①) by rotating the shuttle ring. Then, select a function number (②) by rotating the JogDial.

	①	②
LCD MENU	SYS 301	
System Setup		

**Note:** Refer to pp. 48 to 51 for selectable functions.

- Press the ENTER or CAM (SET) button.  
The sub menu of selected function will appear on the LCD.

```
System Setup      301
  On  Off
```

- Perform the operations to activate the selected function.  
The operating procedure differs depending on each function. Refer to pp. 55 to p. 73.
- To exit the sub menu, press the EXIT or MON (ESC) button. The LCD display will return to the main menu.

```
LCD MENU      SYS 301
System Setup
```

- To exit the main menu, press the EXIT or MON (ESC) button again. The LCD display will return to the default status.

```
Mon01 Cam016   HD316
  F1   F2     F3   F4
```

## ■ Factory Default Setting of Button Functions and Joystick Button Functions

The following functions have been assigned to the function (F1 to F8) buttons and joystick function (A, B, and top) buttons.

**Note:** To change the default assignments, refer to To Assign Menu Functions to Function Buttons, or p. 53 To Assign Menu Functions to Joystick Function Buttons.

### F1: Camera Setup

```
Camera Setup      F1
  On  Off  Rst A.Rst
```

### F2: Auto Mode

```
Auto Mode      F2
  Seq Sort Pan Patrol
```

### F3: BW Mode

```
BW Mode      F3
  On Off Auto1 Auto2
```

### F4: Patrol Learn

```
Patrol Learn      F4
  Start Stop
```

### F5 (SHIFT + F1): System Setup

```
System Setup      F5
  On  Off
```

### F6 (SHIFT + F2): HD300 A – B Repeat

```
HD300 A-B Repeat  F6
  Start End      Cancel
```

### F7 (SHIFT + F3): HD300 Listed

```
HD300 Listed      F7
  On  Off
```

### F8 (SHIFT + F4): HD300 Disk Select

```
HD300 DiskSelect  F8
  Nr-A Cp-A Cpy1 Cpy2
```

### A: Iris Reset

```
Iris Reset      A
```

### B: Auto Focus

```
Auto Focus      B
```

### Top: Auto Focus

```
Auto Focus      J/S
```

## ■ To Assign Menu Functions to Function Buttons

All menu functions are assignable to the function (F1 to F8) buttons. (Refer to pp. 55 to 73 for each function.)

- Press the MENU button.  
“Camera Setup” main menu will appear on the LCD.

```
LCD MENU      CAM 101
Camera Setup
```

2. Select a desired function.  
Select a desired category by rotating the shuttle ring.

```
LCD MENU      SYS 301
System Setup
```

3. Select a function name by rotating the JogDial.

```
LCD MENU      SYS 305
Mux Still
```

- You can skip Step 2 if you know what function to recall. In this case, enter a function number, and press the ENTER button.

4. Press the function button you wish to assign the function for two seconds. The function will be assigned to the button, and the message will appear for a few seconds.

```
Mux Still      305
Assign F2
```

**Notes:**

- To assign menu functions to F5 to F8 buttons, press one of the F1 to F4 buttons for two seconds while holding down the SHIFT button.
- The setting procedure differs depending on each function. Refer to pp. 55 to 73.

5. To exit the menu, press the EXIT or MON (ESC) button. The LCD display will return to the default status.

## ■ To Assign Menu Functions to Joystick Function Buttons

Joystick button functions are assignable to the A, B, or top button on the 3D joystick unit. (Refer to p. 68 to 72 for each function.)

1. Perform Step 1 to 3 in “To Assign Menu Functions to Function Buttons”. (Refer to p. 52.)

**Note:** Skip the next step when assigning neither “Camera Function” nor “System Function”.

2. Enter a desired camera or system function number with the numeric buttons. The entered number will appear on the LCD for a few seconds.

```
J/S MENU      ____1
Camera Function
```

**Notes:**

- The illustration is an example in which Camera Function Number 1 is pressed.
- Refer to the operating instruction of camera for details on camera function.
- Refer to the operating instruction of system unit for details on system function.

3. Press the A, B or top button for two seconds.
  - The menu function will be assigned to the button you pressed.
  - “Assign” message will appear for a few seconds, as shown in the illustration.

```
Camera Function 501
Assign A Code= 1
```

**Note:** The illustration is an example in which “Camera Function Code = 1” has been assigned to the A button.

4. To exit the menu, press the EXIT or MON (ESC) button. The LCD will return to the normal display.

## ■ To Recall Button Functions and Joystick Button Functions

You can recall the assigned button functions and joystick button functions as follows.

1. Press one of the function buttons (F1 to F4/F5 to F8) or one of the joystick function buttons (A, B, and top buttons). The sub menu of recalled function will appear on the LCD.

```
Mon02 Cam128 HD316
F1 F2 F3 F4
```



```
Camera Setup F1
On Off Rst A.Rst
```

**Note:** To recall a function assigned to the F5 to F8 button, press the function button while holding down the SHIFT button.

2. Perform the operations to activate the function. The operating procedure differs depending on each function. Refer to pp. 55 to 73.

**Note:** To cancel the function, press the EXIT or MON (ESC) button. The LCD display will return to the normal status.

## ■ To Check Button Functions and Joystick Button Functions

You can check the functions assigned to the function (F1 to F8) buttons and joystick function (A, B, and top) buttons.

1. Press the MENU button while holding down the SHIFT button. The F1 button function will appear on the LCD.

Function Check	F1
Camera Setup	101

**Note:** This illustration is an example in which "Camera Setup" is assigned to the F1 button.

2. To check other (joystick) button functions, rotate the JogDial. The button functions and joystick button function will appear on the LCD in the following order.

Function Check	F1
Camera Setup	101



Function Check	F8
System Setup	301



Function Check	A
Cam Func "4096"	501



Function Check	B
Sys Func "999"	502



Function Check	J/S
Auto Focus	506



Function Check	F1
Camera Setup	101



3. To finish checking the function, press the EXIT or MON (ESC) button.  
The LCD will return to the normal status.

# MENU FUNCTION DETAILS

## ■ Camera Functions

### ● Camera Setup

You can display the setup menu of selected camera on the active monitor.

**Note:** The details on the setup menu differ depending on camera models. Refer to the operating instructions of camera.

1. Display "Camera Setup" sub menu. (Refer to Step 1 to 4 of p. 51 To Recall Menu Functions.)

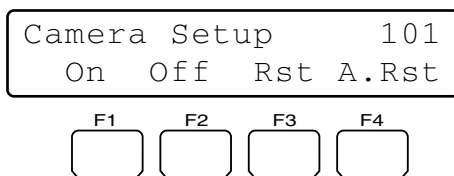

2. Press the F1 button.

The setup menu of selected camera will appear on the active monitor, and "▶" mark will light up beside "On".

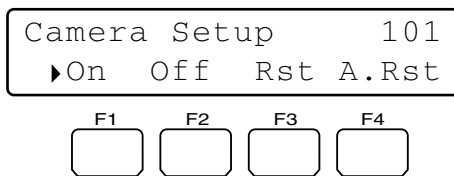

3. Perform the camera setting while watching the setup menu on the monitor.

### Available controls and functions

<Main unit>

**JogDial clockwise or counterclockwise:** Changes the selected parameter.

**+ button:** Increases a numeric value.

**- button:** Decreases a numeric value.

**CAM (SET) button:** Determines the selected parameter and moves to the sub menu.

**MON (ESC) or EXIT button:** Returns to the upper menu.

**F3 button:** Displays the special menu.

**F4 button:** Resets all the camera settings to the factory default.

<Joystick unit>

**3D joystick upward (▲):** Moves the cursor up.

**3D joystick downward (▼):** Moves the cursor down.

**3D joystick to the left (◀):** Moves the cursor to the left.

**3D joystick to the right (▶):** Moves the cursor to the right.

**Top button:** Determines the selected parameter and moves to the sub menu.

4. Press the F2 button.

The setup menu of selected camera will be closed, and "▶" mark will go out.

### ● Auto Mode

You can activate an auto mode (auto sequence, auto sort, auto pan, and camera patrol) for the selected camera.

**Note:** Refer to the operating instructions of camera for details on auto mode.

1. Display "Auto Mode" sub menu. (Refer to Step 1 to 4 of p. 51 To Recall Menu Functions.)

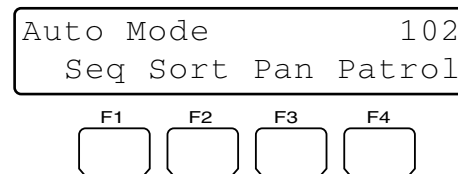

2. Select a desired function by pressing one of the F1 to F4 buttons. Auto mode will be activated.

### Available buttons and functions

#### F1: Seq

Activates the sequence mode.

#### F2: Sort

Activates the sort mode.

#### F3: Pan

Activates the auto pan mode.

#### F4: Patrol

Activates the patrol mode.

**Note:** Auto mode will be canceled when you pan or tilt the selected camera by moving the 3D joystick.

### ● BW Mode

You can change the color mode of camera images from color to black and white. This function is activated to improve the camera sensitivity when monitoring a dark place.

**Note:** Refer to the operating instructions of camera for details on auto mode.

1. Display "BW Mode" sub menu. (Refer to Step 1 to 4 of p. 51 To Recall Menu Functions.)

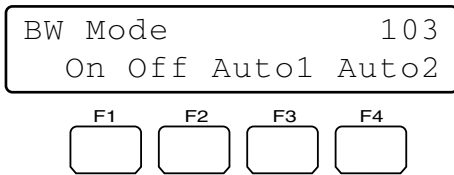

2. Press one of the F1 to F4 buttons.  
BW mode will be activated.

### Available buttons and functions

#### F1: On

Changes the camera image from color to black and white.

#### F2: Off

Changes the camera image from black and white to color .

#### F3: Auto1

Activates Auto 1 mode. (The camera selects black and white mode if the picture is dark, or color mode if the picture is bright enough.)

#### F4: Auto2

Activates Auto 2 mode. (The camera detects the light source type to prevent malfunction. This setting is applicable when using a near-infrared light source in a dark place.)

#### Notes:

- The camera detects light source based on the information the CCD image pickup element receives. If an object is continuously moving or has the same color as the background, the object may not be properly recognized. When activating Auto 2 mode, make sure the wavelength of light source is 800 nm or more.
- If the available parameters for selected camera are ON, OFF, and AUTO, you can activate AUTO by pressing the F3 button.

### To recover the color mode

Press the F2 button. The color mode is recovered for the camera image.

## ● Patrol Learn

You will perform the patrol learn setup.

**Note:** Refer to the operating instructions of camera for details on patrol learn.

1. Display "Patrol Learn" sub menu. (Refer to Step 1 to 4 of p. 51 To Recall Menu Functions.)



2. Press the F1 button.  
The patrol learn setup will start.
3. Perform desired camera operations by moving the 3D joystick or zoom wheel controller, etc.  
The following controls are available for patrol learn.
  - Panning/Tilting (3D joystick)
  - Iris control (IRIS OPEN/CLOSE buttons)
  - Focus control (FOCUS FAR/NEAR buttons)
  - Zoom control (Zoom wheel controller)
  - Preset position

**Note:** The available total time of patrol learn differs depending on cameras. When the time is over, the patrol learn setup will automatically stop.

4. To quit the patrol learn setup, press the F2 button.

### To activate preset positions during the patrol learn

To move the camera to a preset position during the patrol learn, you will perform the following operations after Step 2 of Patrol Learn.

1. Enter a preset position number.  
The entered number will appear on the LCD.

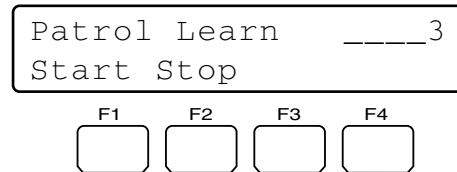

**Note:** To cancel the entry, press the CLEAR button.

2. Press the PRESET/PGM PRESET button.  
"Pre=nn" (nn is a number.) will blink on the LCD, and the camera will move to the preset position.

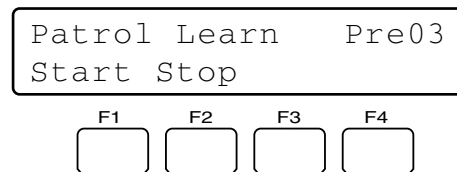

**Note:** After the camera has moved to the preset position, "Pre-nn" will go out.



## ● Auto Pan Setup and Activation

You will set up and activate the auto pan function. The camera can pan between the start and end points you will set.

### To set the start and end point of auto pan

1. Display "Auto Pan" sub menu. (Refer to Step 1 to 4 of p. 51 To Recall Menu Functions.)

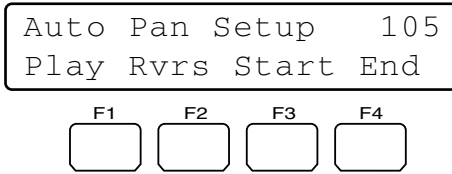

2. By moving the 3D joystick, move the camera to a point you wish to start auto pan.
3. Press the F3 button.  
The start point of auto pan will be set.
4. By moving the 3D joystick, move the camera to a point you wish to end auto pan.
5. Press the F4 button.  
The end point of auto pan will be set.

### To activate auto pan

Press the F1 button.  
The auto pan will be activated, and the camera will pan between the set.

#### Notes:

- When you press the F2 button, the auto pan direction will be reversed.
- Auto pan will be canceled when you pan or tilt the selected camera by moving the 3D joystick.

## ■ Recorder Functions

### ● Disk Selection (WJ-HD300 Series Only)

You will specify a disk for search playback.

1. Display "HD300 DiskSelect" sub menu. (Refer to Step 1 to 4 of p. 51 To Recall Menu Functions.)

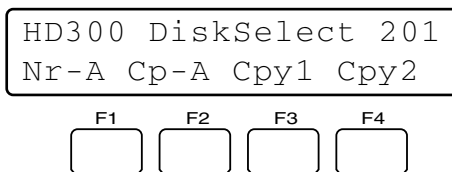

2. Press one of the F1 to F4 buttons.  
The specified disk will be selected.

### Available buttons and functions

#### F1: Nr-A

Specifies the normal or event recording area for playback.

#### F2: Cp-A

Specifies the copy area for playback.

#### F3: Cpy1

This function is reserved for future use.

#### F4: Cpy2

This function is reserved for future use.

3. When you specify a disk, the search list display will appear on the active monitor, and "Search Mode" menu will appear on the LCD. Then, perform the search playback operation. (Refer to p. 35 Search Playback.)



### ● A-B Repeat Playback Setting (WJ-HD300 Series Only)

You can playback the recorded images repeatedly by specifying the start point (A) and end point (B).

1. Display "HD300 A-B Repeat" sub menu. (Refer to Step 1 to 4 of p. 51 To Recall Menu Functions.)

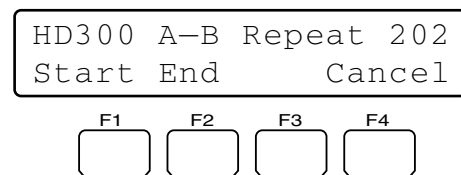

2. During playback, press the F1 button at the point you wish to start playback. The playback start point (A) will be set.

**Note:** To cancel the start point, press the F4 button.

3. Press the F2 button at the point you wish to end playback. The playback end point (B) will be set, and the repeat playback will be performed between (A) and (B).

## ● Filtering ON/OFF (WJ-HD300 Series Only)

During the filtering playback, the searching filter will be temporarily canceled or recovered.

1. Display "HD300 Listed" sub menu. (Refer to Step 1 to 4 of p. 51 To Recall Menu Functions.)

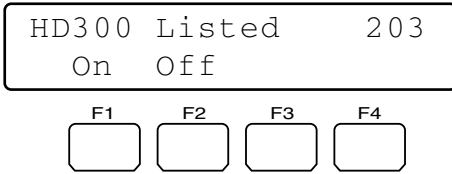

2. Press the F2 button.  
The searching filter will be canceled, and "▶" mark will light up beside "Off".

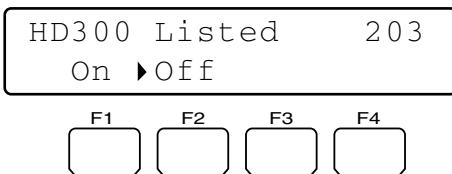

**Note:** To recover the searching filter, press the F1 button.  
The searching filter will be recovered, and "▶" mark will light up beside "On".

## ● Displaying Camera and Playback Image (WJ-HD500 Series Only)

While camera images are being displayed in the multi-screen display, playback picture can be displayed on one of the multiscreen segments. (When the spot mode is activated for the camera image on the monitor, playback picture cannot be displayed.)

**Note:** Refer to the operating instructions of recorder for details on this function.

1. Display "HD500 V-Multi" sub menu. (Refer to Step 1 to 4 of p. 51 To Recall Menu Functions.)

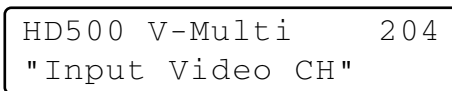

2. Enter the channel number of camera whose playback picture you wish to display.  
The entered number will appear on the LCD.

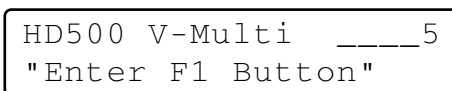

**Note:** To cancel the numeric entry, press the CLEAR button.

3. Press the F1 button.
  - Playback picture will be displayed on the multi-screen monitor.
  - The specified camera channel will blink on the LCD for a few seconds, and the LCD display will return to Step 1.



**Note:** To quit the playback on the multiscreen monitor, press the STOP button.

## ■ System Functions

### ● System Setup

You can display the setup menu of selected system unit on the active monitor.

**Note:** The details on the setup menu differ depending on system units. Refer to the operating instructions of system unit.

1. Display "System Setup" sub menu. (Refer to Step 1 to 4 of p. 51 To Recall Menu Functions.)

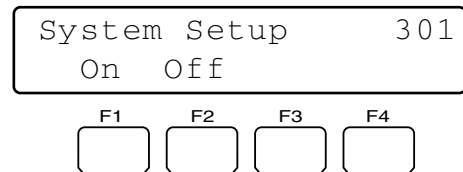

2. Press the F1 button.  
The setup menu of selected system unit will appear on the active monitor, and "▶" mark will light up beside "On".

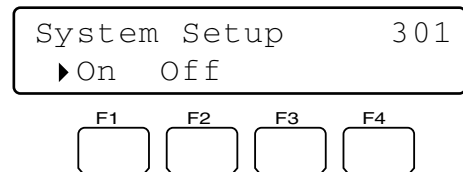

3. Perform the camera setting while watching the setup menu on the monitor.

## Available controls and functions

<Main unit>

**Shuttle ring clockwise:** Moves to the next page.

**Shuttle ring counterclockwise:** Moves to the previous page.

**JogDial clockwise or counterclockwise:** Changes the selected parameter.

**+ button:** Increases a numeric value.

**- button:** Decreases a numeric value.

**Numeric buttons:** Enters a numeric parameter.

**CLEAR button (WJ-HD300 Series Only):** Clears an entry such as a password.

**Button 0 (WJ-HD300 Series Only):** If you enter only "0" for a parameter, the parameter will be cleared.

**CAM (SET) button:** Determines the selected parameter and moves to the sub menu.

**MON (ESC) or EXIT button:** Returns to the upper menu.

<Joystick unit>

**3D joystick upward (▲):** Moves the cursor up.

**3D joystick downward (▼):** Moves the cursor down.

**3D joystick leftward (◀):** Moves the cursor to the left.

**3D joystick rightward (▶):** Moves the cursor to the right.

**Zoom wheel controller to the right:** Moves to the next page.

**Zoom wheel controller to the left:** Moves to the previous page.

**Top button:** Determines the selected parameter and moves to the sub menu.

4. Press the F2 button.

The setup menu of selected system unit will be closed, and "▶" mark will light up beside "Off".

## ● VCR/Camera Selection (WJ-FS416, etc: Available Only for Switchers Installing Multiplexer Board)

If a Multiplexer board is installed inside the switcher, you can activate either VCR playback or camera picture display on an active monitor.

1. Display "Mux VCR/CAM" sub menu. (Refer to Step 1 to 4 of p. 51 To Recall Menu Functions.)

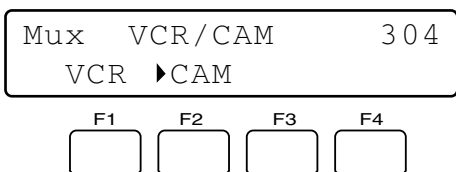

**Note:** "▶" mark will light up beside the activated setting.

2. Press the F1 or F2 button.

The monitor display will be changed between playback pictures and live images, and "▶" mark will light up beside the activated setting.

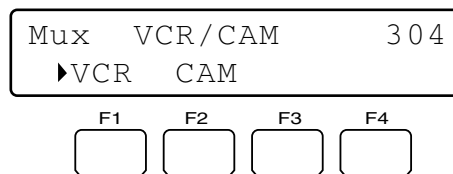

## Available buttons and functions

**F1: VCR**

Activates VCR playback.

**F2: CAM**

Activates camera picture display.

**Note:** If the Multiplexer board is receiving no video input signal, "▶" mark will light up beside VCR.

## ● Still Mode (WJ-FS416, etc: Available Only for Switchers Installing Multiplexer Board)

If a Multiplexer board is installed inside the switcher, you can change the multiscreen monitor display from the moving mode to the still mode.

1. Display "Mux Still" sub menu. (Refer to Step 1 to 4 of p. 51 To Recall Menu Functions.)

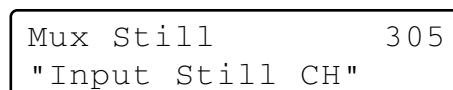

2. Select the camera channel you wish to change to the still mode by performing either of the following.

- Press the + or - button.
- Enter the camera number with the numeric buttons.

The entered number will appear on the LCD.

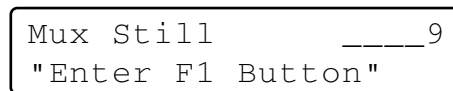

**Notes:**

- To cancel the numeric entry, press the CLEAR button.
- To activate the still mode for all camera channels or spot monitor display, skip this step or enter "0".

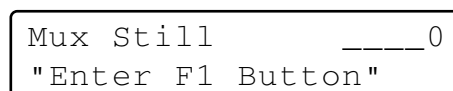

- Press the F1 button.
  - The still mode will be activated for the selected camera channel.
  - The specified camera channel will blink on the LCD for a few seconds, and the LCD display will return to Step 1.

```
Mux Still          305
  Still CH=__9
```

```
Mux Still          305
  Still CH=All
```

**Note:** To return the multiscreen monitor display from the still mode to moving mode, perform Step 1 to 3 again.

## ■ Controller Functions

### ● Camera Cleaning

- Display "Camera Cleaning" sub menu. (Refer to Step 1 to 4 of p. 51 To Recall Menu Functions.)

```
Camera Cleaning  401
Start Cancel 001-256
```

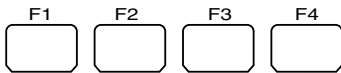

- Select the camera to clean first by performing one of the following.
  - Rotate the JogDial clockwise or counterclockwise.
  - Press the + or - button.
  - Enter the camera number with the numeric buttons.

```
Camera Cleaning  401
Start Cancel 003-256
```

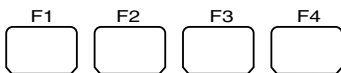

- Rotate the shuttle ring clockwise or move the 3D joystick to the right. The cursor will jump to the next item.
- Select the camera to clean last by performing one of the following.
  - Rotate the JogDial clockwise or counterclockwise.
  - Press the + or - button.
  - Enter the camera number with the numeric buttons.

```
Camera Cleaning  401
Start Cancel 003-064
```

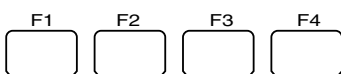

**Note:** To return the cursor to the previous item, rotate the shuttle ring counterclockwise or move the 3D joystick to the left.

- Press the F1 button.
 

Camera cleaning will be cleared from the first to the last camera you have set.

During the cleaning, the current channel number will be displayed on the LCD.

```
Camera Cleaning  401
Start Cancel Cam028
```

When the all cameras have started to be cleaned, "End" will appear on the LCD.

```
Camera Cleaning  401
Start Cancel End
```

#### Notes:

- To quit the cleaning, press the F2 button.
- It may take a few minutes since "End" appears on the LCD until camera cleaning ends.
- If you have selected a lower channel for the last camera than the first camera, "Invalid" will appear on the LCD.

```
Invalid
```

In this case, select a higher camera channel for the last camera.

### ● Time & Date Search Display Pattern

You can set up the clock display pattern of the LCD for the time & date search. You can select a desired one from 10 patterns.

- Display "Time & Date Type" sub menu. (Refer to Step 1 to 4 of p. 51 To Recall Menu Functions.)

```
Time&Date Type  402
Mmm/DD/YYYY HH:MM 12
```

- Select a desired display pattern by performing either of the following.
  - Rotate the JogDial clockwise or counterclockwise.
  - Press the + or - button.

```
Time&Date Type  402
DD/MM/YYYY HH:MM 24
```

The following patterns are available.

Display pattern	Display Example
DD/MM/YYYY HH:MM 24	21/08/2001 22:55 24 *2
MM/DD/YYYY HH:MM 24	08/21/2001 22:55 24
DD/Mmm/YYYY HH:MM 24	21/Aug/2001 22:55 24
YYYY/MM/DD HH:MM 24	2001/08/21 22:55 24
Mmm/DD/YYYY HH:MM 24	Aug/21/2001 22:55 24
DD/MM/YYYY HH:MM 12	21/08/2001 10:55 12
MM/DD/YYYY HH:MM 12	08/21/2001 10:55 12
DD/Mmm/YYYY HH:MM 12	21/Aug/2001 10:55 12
YYYY/MM/DD HH:MM 12	2001/08/21 10:55 12
Mmm/DD/YYYY HH:MM 12	Aug/21/2001 10:55 12 *1

\*1 Factory default for U.S. models

\*2 Factory default for Europe models

**Note:** In this diagram, “12” means 12 hour display and “24” means 24 hour display.

- Press the ENTER or CAM (SET) button.  
“Set OK?” will appear on the LCD.

```
Time&Date Type 402
Type0 Set OK?
```

**Note:** To cancel the setting, press the EXIT or MON (ESC) button.

- Press the ENTER or CAM (SET) button again.  
The display pattern will be set.  
“Memory” will appear on the LCD for a few seconds, and the LCD display will return to Step 1.

```
Time&Date Type 402
Type0 Memory
```

## ● Auto Login/Logout Setup

If auto login or auto logout is activated, operators can log into or log out of the system automatically.

**Note:** You cannot set both Auto Login and Auto Logout to ON for the same system controller.

- Display “Auto Login” sub menu. (Refer to Step 1 to 4 of p. 51 To Recall Menu Functions.)

```
Auto Login/out 403
Cont No.1 Off
```

- Select a system controller to activate auto login or auto logout by performing either of the following.
  - Rotate the JogDial clockwise or counterclockwise.
  - Press the + or – button.

```
Auto Login/out 403
Cont No.6 Off
```

**Note:** The factory default is “Cont No. 1”.

- Rotate the shuttle ring clockwise or move the 3D joystick to the right.
- To activate auto login, select an operator (Operator 1 to 16) by performing the following.
  - Rotate the JogDial clockwise or counterclockwise.
  - Press the + or – button.

```
Auto Login/out 403
Cont No.6 Operator16
```

To activate auto logout, select the duration until auto logout (Logout 5 to 120)\* by performing the following.

\* The numbers mean minutes.

- Rotate the JogDial clockwise or counterclockwise.
- Press the + or – button.

```
Auto Login/out 403
Cont No.6 Logout 30
```

### Notes:

- Parameters can be changed as follows.  
Operator 1 → Operator 2 ...→ Operator 16 → Logout 5 → Logout 10 ...→ Logout 120 → Operator 1 ...
- To return the cursor to Cont No. n, rotate the shuttle ring counterclockwise or move the 3D joystick to the left.
- Auto Logout setting will be activated after you log into the system again.

- Press the ENTER or CAM (SET) button.  
“Set OK?” will appear on the LCD.

```
Auto Login/out 403
Cont No.6 Set OK?
```

**Note:** To cancel the setting, press the EXIT or MON (ESC) button.

- Press the ENTER or CAM (SET) button again.  
Auto login will be set.  
“Memory” will appear on the LCD for a few seconds, and the LCD display will return to Step 1.

```
Auto Login/out 403
Cont No.6 Memory
```

## To deactivate auto login or auto logout

- Select a system controller to deactivate auto login or auto logout by performing either of the following.
  - Rotate the JogDial clockwise or counterclockwise.
  - Press the + or – button.

```
Auto Login/out 403
Cont No.6 Operator16
```

```
Auto Login/out 403
Cont No.6 Logout 30
```

- Press the CLEAR button.  
“Clear OK?” will appear on the LCD.

```
Auto Login/out    403
Cont No.6 Clear OK?
```

**Note:** To cancel deactivating auto login, press the EXIT or MON (ESC) button.

- Press the ENTER or CAM (SET) button.  
Auto login or auto logout will be deactivated.  
“Erased” will appear on the LCD for a few seconds, and the LCD display will return to Step 1.

```
Auto Login/out    403
Cont No.6 Erased
```

## ● Operator Registration or Change

You can register new operators or change the parameter settings. Up to 16 operators are registrable in the system.

### Notes:

- Refer to p. 29 Operation Start (Login) for the factory default.
- To return to the previous step, press the EXIT or MON (ESC) button.

- Display “Operator Setup” sub menu. (Refer to Step 1 to 4 of p. 51 To Recall Menu Functions.)

```
Operator Setup    404
Operator01
```

- Select an operator to register or change the settings by performing either of the following.
  - Rotate the JogDial clockwise or counterclockwise.
  - Press the + or – button.

```
Operator Setup    404
Operator02
```

**Note:** When registering a new operator, select an operator number beside which “No Assign” is displayed.

```
Operator Setup    404
Operator07 No Assign
```

- Press the ENTER or CAM (SET) button.  
“User ID” setting menu will appear on the LCD.

```
Operator07        404
User ID=          1
```

- Enter a user ID by pressing the numeric buttons.  
“1” to “99999” are available for the user ID number.

```
Operator07        404
User ID=          777
```

**Note:** If you have entered a wrong user ID, press the CLEAR button.

- Press the ENTER or CAM (SET) button.  
The password entry form will appear on the LCD.

```
Operator07        404
Password=         12345
```

- Enter a password by pressing the numeric buttons.  
“1” to “99999” are available for the password.

```
Operator07        404
Password=         333
```

**Note:** If you have entered a wrong password, press the CLEAR button.

- Press the ENTER or CAM (SET) button.  
“Function Level” setting menu will appear on the LCD.

```
Operator07        404
Function Level    = 1
```

- Set the function level by performing either of the following.
  - Rotate the JogDial clockwise or counterclockwise.
  - Press the + or – button.

```
Operator07        404
Function Level    = 2
```

### Notes:

- Refer to p. 63 Function Level Setting for details on function level.
- You cannot change the function level of Operator 1. If you try to change, “Level 1 Fixed” will appear on the LCD.

```
Operator01        404
Level1 Fixed
```

- Press the ENTER or CAM (SET) button.  
“Camera Level” setting menu will appear on the LCD.

```
Operator07        404
Camera Level      = 1
```

10. Set the camera level by performing either of the following.

- Rotate the JogDial clockwise or counterclockwise.
- Press the + or – button.

```
Operator07      404
Camera Level   = 2
```

**Notes:**

- Refer to p. 64 Camera Level Setting for details on camera level.
- You cannot change the camera level of Operator 1. If you try to change, “Level 1 Fixed” will appear on the LCD.

```
Operator01      404
Level1 Fixed
```

11. Press the ENTER or CAM (SET) button.  
“Set OK?” will appear on the LCD.

```
Operator07      404
Set OK?
```

12. Press the ENTER or CAM (SET) button again.  
The new operator and the settings will be registered.  
“Memory” will appear on the LCD for a few seconds,  
and the LCD display will return to Step 1.

```
Operator07      404
Memory
```

**To delete an operator**

**Note:** You cannot delete Operator 1. If you try to delete, “Level1 Fixed” will appear on the LCD.

```
Operator01      404
Level1 Fixed
```

1. Select an operator to delete by performing either of the following.

- Rotate the JogDial clockwise or counterclockwise.
- Press the + or – button.

```
Operator Setup  404
Operator07
```

**Note:** If you select an operator not registered, “No Assign” will appear beside the operator number.

```
Operator Setup  404
Operator15 No Assign
```

2. Press the CLEAR button.  
“Clear OK?” will appear on the LCD.

```
Operator Setup  404
Operator07 Clear OK?
```

**Note:** To cancel deleting the operator, press the EXIT or MON (ESC) button.

3. Press the ENTER or CAM (SET) button.

- The operator will be deleted.
- “Erased” will appear on the LCD for a few seconds, and the LCD display will return to Step 1.

```
Operator Setup  404
Operator07 Erased
```

**Note:** After the operator has been deleted, “No Assign” will appear beside the operator number.

```
Operator Setup  404
Operator07 No Assign
```

● **Function Level Setting**

You can change the function levels for each button (except for numeric buttons) of main unit and 3D joystick unit. The function levels range between Table No. 1 (highest level) and 3 (Lowest level).

**Note:** Table No. 1 is fixed to E (Enabled) for all the functions.

1. Display “Function Level” sub menu. (Refer to Step 1 to 4 of p. 51 To Recall Menu Functions.)

```
Function Level  405
Table No.      =1
```

2. Select a desired table (= function level) by performing either of the following.

- Rotate the JogDial clockwise or counterclockwise.
- Press the + or – button.
- Enter the table number with the numeric buttons.

```
Function Level  405
Table No.      =2
```

3. Press the CAM (SET) button.  
The setting menu for the selected table will appear on the LCD.

```
Function Table2 405
01 MENU        =E
```

4. Select a desired function by performing one of the following.
- Rotate the JogDial clockwise or counterclockwise.
  - Press the + or – button.
  - Enter the function number with the numeric buttons.
- The function setting will appear on the LCD.

```
Function Table2  405
08 IRIS OPEN/CLOSE=E
```

The following diagram describes the function settings changeable and their factory defaults.

Function	Table 2	Table 3
01 MENU	D	D
02 F1 – F4	E	E
03 F5 – F8	E	E
04 A B	E	E
05 TOP SW	E	E
06 JOYSTICK	E	E
07 FOCUS NEAR/FAR	E	E
08 IRIS OPEN/CLOSE	E	D
09 CAM/SET	E	E
10 MON/ESC	E	E
11 UNIT	E	E
12 RECORDER	E	E
13 CAM POSI	E	E
14 PRESET	E	E
15 PGM PRESET	D	D
16 HISTORY	E	E
17 -/+	E	E
18 JOG DIAL	E	E
19 SHUTTLE RING	E	E
20 SHUTTLE HOLD	E	E
21 PLAY/PAUSE	E	E
22 STOP	E	E
23 REC	E	D
24 ALM SUSPEND	E	D
25 ALM RESET	E	E
26 OSD	E	E
27 ALM RECALL	E	E
28 SEQ PAUSE	E	E
29 SEQUENCE	E	E
30 MULTI SCREEN	E	E
31 EL-ZOOM	E	E
32 AUX1 ON/OFF	E	E
33 AUX2 ON/OFF	E	E
34 DEF ON/OFF	E	E
35 WIPER ON	E	E
36 SYS FUNC	D	D
37 CAM FUNC	D	D
38 GO TO LAST	E	E
39 MARK	E	E
40 SEARCH	E	E
41 T&D SEARCH	E	E

E=Enabled, D=Disabled

5. Rotate the shuttle ring clockwise or move the 3D joystick to the right. The cursor will jump to the next item.

```
Function Table2  405
08 IRIS OPEN/CLOSE=E
```

**Note:** To return to Step 4, rotate the shuttle ring counterclockwise or move the 3D joystick to the left.

6. Select E or D by performing either of the following.
- Rotate the JogDial clockwise or counterclockwise.
  - Press the + or – button.

```
Function Table2  405
08 IRIS OPEN/CLOSE=D
```

**Note:** To change the settings of other functions, repeat Step 4 to 6.

7. Press the ENTER or CAM (SET) button. “Set OK?” will appear on the LCD.

```
Function Table2  405
Set OK?
```

**Note:** To cancel the setting, press the EXIT or MON (ESC) button. The LCD display will return to Step 6.

8. Press the ENTER or CAM (SET) button again.

```
Function Table2  405
Memory
```

The function levels will be set for the selected table. “Memory” will appear on the LCD for a few seconds, and the LCD display will return to Step 1.

## ● Camera Level Setting

You can change the camera levels for each operator. The camera levels range between Table No. 1 (highest level) and 3 (Lowest level).

### Notes:

- Table No. 1 is fixed to E (Enabled) for all cameras.
- As the factory default, Table No. 2 and 3 are set to E for all cameras.

1. Display “Camera Level” sub menu. (Refer to Step 1 to 4 of p. 51 To Recall Menu Functions.)

```
Camera Level      406
Table No.        =1
```

2. Select a desired table (= camera level) by performing one of the following.

- Rotate the JogDial clockwise or counterclockwise.
- Press the + or – button.
- Enter the function number with the numeric buttons.

```
Camera Level      406
Table No.        =3
```

3. Press the CAM (SET) button. The setting menu for the selected table will appear on the LCD.



Camera Table3	406
Cam001	=E

- Select a desired camera channel by performing one of the following.
  - Rotate the JogDial clockwise or counterclockwise.
  - Press the + or - button.
  - Enter the camera number with the numeric buttons.

Camera Table3	406
Cam064	=E

**Note:** You can select a camera channel from 1 to 256.

- Rotate the shuttle ring clockwise or move the 3D joystick to the right. The cursor will jump to the next item.

Camera Table3	406
Cam064	=E

**Note:** To return to Step 4, rotate the shuttle ring counterclockwise or move the 3D joystick to the left.

- Select E (= Enabled) or D (= Disabled) by performing either of the following.
  - Rotate the JogDial clockwise or counterclockwise.
  - Press the + or - button.

Camera Table3	406
Cam064	=D

**E (= Enabled):** The operator can display the camera image on the monitor and control panning/tilting. (VIEW & CONTROL)

**D (= Disabled):** The operator can display the camera image on the monitor, but cannot control the panning/tilting. (VIEW ONLY)

**Note:** To change the settings of other cameras, repeat Step 4 to 6.

- Press the ENTER or CAM (SET) button. "Set OK?" will appear on the LCD.

Camera Table3	406
Set OK?	

**Note:** To cancel the setting, press the EXIT or MON (ESC) button. The LCD display will return to Step 6.

- Press the ENTER or CAM (SET) button again. The camera levels will be set for the selected table. "Memory" will appear on the LCD for a few seconds, and the LCD display will return to Step 1.

Camera Table3	406
Memory	

## ● Camera Position Registration or Clearing

This system controller can memorize camera position numbers, which are the combination of camera numbers and preset position numbers. By entering a camera position number, you can select a desired camera and preset position at a time. You can register up to 1 000 camera position numbers.

- Display "Cam Posi Map" sub menu. (Refer to Step 1 to 4 of p. 51 To Recall Menu Functions.)

Cam Posi Map	407
Cam-P001	C--- Pre--

- Select a camera position number to register by performing one of the following.
  - Rotate the JogDial clockwise or counterclockwise.
  - Press the + or - button.
  - Enter the camera position number with the numeric buttons.

Cam Posi Map	407
Cam-P016	C--- Pre--

### Notes:

- To register a new position number, press the numeric buttons.
- You can select a camera position number from 0 to 999.

- Rotate the shuttle ring clockwise or move the 3D joystick to the right. The cursor will jump to the next item.

**Note:** To return to Step 2, rotate the shuttle ring counterclockwise or move the 3D joystick to the left.

- Select a desired camera channel by performing one of the following.
  - Rotate the JogDial clockwise or counterclockwise.
  - Press the + or - button.
  - Enter the camera number with the numeric buttons.

Cam Posi Map	407
Cam-P016	C005 Pre--

**Note:** You can select a camera channel from 1 to 999.

- Rotate the shuttle ring clockwise or move the 3D joystick to the right. The cursor will jump to the next item.

**Note:** To return to Step 4, rotate the shuttle ring counterclockwise or move the 3D joystick to the left.

- Select a desired preset position number by performing either of the following.
  - Rotate the JogDial clockwise or counterclockwise.
  - Press the + or – button.

```
Cam Posi Map      407
Cam-P016  C005 Pre32
```

**Note:** You can select a preset position number from 1 to 64.

- Press the ENTER or CAM (SET) button. “Set OK?” will appear on the LCD.

```
Cam Posi Map      407
Cam-P016  Set OK?
```

**Note:** To cancel the setting, press the EXIT or MON (ESC) button. The LCD display will return to Step 6.

- Press the ENTER or CAM (SET) button again. The specified camera channel and preset position number will be set for the selected camera position. “Memory” will appear on the LCD for a few seconds, and the LCD display will return to Step 1.

```
Cam Posi Map      407
Cam-P016  Memory
```

## To delete a camera position

- Select a camera position to delete by performing either of the following.
  - Rotate the JogDial clockwise or counterclockwise.
  - Press the + or – button.

```
Cam Posi Map      407
Cam-P016  C005 Pre32
```

- Press the CLEAR button. “Clear OK?” will appear on the LCD.

```
Cam Posi Map      407
Cam-P016  Clear OK?
```

**Note:** To cancel deleting the camera position, press the EXIT or MON (ESC) button.

- Press the ENTER or CAM (SET) button. The camera position will be deleted. “Erased” will appear on the LCD for a few seconds, and the LCD display will return to Step 1.

```
Cam Posi Map      407
Cam-P016  Erased
```

## ● Associating Camera Numbers with Unit Numbers

You can register camera-unit maps (the association of camera numbers and unit numbers). Up to 256 camera unit maps can be registered. You can select a camera by entering the camera channel alone, even if the camera is connected to system unit not currently selected.

**Note:** If “Enable” is selected in Step 2, you can select only camera numbers associated with unit numbers.

- Display “Cam-Unit Map” sub menu. (Refer to Step 1 to 4 of p. 51 To Recall Menu Functions.)

```
Cam-Unit Map      408
Disable  ▶Enable
```

**Note:** To disable camera-unit maps, display the “▶” mark beside “Disable” by rotating the shuttle ring counterclockwise or moving the 3D joystick to the left.

```
Cam-Unit Map      408
▶Disable  Enable
```

- Press the ENTER or CAM (SET) button. The camera-unit setting will appear on the LCD.

```
Cam-Unit Map      408
Cam001  Unit01
```

- Select a desired camera channel by performing one of the following.
  - Rotate the JogDial clockwise or counterclockwise.
  - Press the + or – button.
  - Enter the camera number with the numeric buttons.

```
Cam-Unit Map      408
Cam016  Unit01
```

### Notes:

- To register a new position number, press the numeric buttons.
- You can select a camera channel from 1 to 256.
- The following are the factory default settings.

### Default settings of camera-unit maps

Cam	Unit
001 to 016	01
017 to 032	02
033 to 048	03
049 to 064	04
065 to 256	--

- Rotate the shuttle ring clockwise or move the 3D joystick to the right. The cursor will jump to the next item.

**Note:** To return to Step 3, rotate the shuttle ring counterclockwise or move the 3D joystick to the left.

5. Select a desired unit number by performing either of the following.
  - Rotate the JogDial clockwise or counterclockwise.
  - Press the + or – button.

```
Cam-Unit Map    408
Cam016         Unit02
```

**Note:** You can select a unit number from 1 to 99.

6. Press the ENTER or CAM (SET) button.  
“Set OK?” will appear on the LCD.

```
Cam-Unit Map    408
Cam016         Set OK?
```

**Note:** To cancel the setting, press the EXIT or MON (ESC) button. The LCD display will return to Step 6.

7. Press the ENTER or CAM (SET) button again.  
The specified camera channel and unit number will be set for the selected camera-unit map.  
“Memory” will appear on the LCD for a few seconds, and the LCD display will return to Step 1.

```
Cam-Unit Map    408
Cam016         Memory
```

## To delete a camera-unit map

1. Perform Step 1 and 4 in p. 66.
2. Press the CLEAR button.  
“Clear OK?” will appear on the LCD.

```
Cam-Unit Map    408
Cam016         Clear OK?
```

**Note:** To cancel deleting the setting, press the EXIT or MON (ESC) button.

3. Press the ENTER or CAM (SET) button.  
The camera-unit map will be deleted.  
“Erased” will appear on the LCD for a few seconds, and the LCD display will return to Step 3.

```
Cam-Unit Map    408
Cam016         Erased
```

**Note:** After all the camera-unit maps have been deleted, “Cam000” will appear for the camera channel area.

## ● Associating Recorder Numbers with Unit Numbers

You can register HDD-unit maps (the association settings of recorder numbers and unit numbers). Up to 16 HDD-unit maps can be registered. You can select a recorder by entering a desired recorder number.

**Note:** As the factory default, recorder numbers have been associated with unit numbers having the same numbers. (“HDD01” with “Unit01”, “HDD02” with “Unit02”...)

1. Display “HDD-Unit Map” sub menu. (Refer to Step 1 to 4 of p. 51 To Recall Menu Functions.)

```
HDD-Unit Map    409
HDD01          Unit01
```

2. Select a desired recorder number by performing either of the following.
  - Rotate the JogDial clockwise or counterclockwise.
  - Press the + or – button.

```
HDD-Unit Map    409
HDD06          Unit06
```

**Note:** You can select a recorder number from 1 to 16.

3. Rotate the shuttle ring clockwise or move the 3D joystick to the right. The cursor will jump to the next item.

**Note:** To return to Step 2, rotate the shuttle ring counterclockwise or move the 3D joystick to the left.

4. Select a desired unit number by performing either of the following.
  - Rotate the JogDial clockwise or counterclockwise.
  - Press the + or – button.

```
HDD-Unit Map    409
HDD06          Unit05
```

**Note:** You can select a unit number from 1 to 99.

5. Press the ENTER or CAM (SET) button.  
“Set OK?” will appear on the LCD.

```
HDD-Unit Map    409
HDD06          Set OK?
```

**Note:** To cancel the setting, press the EXIT or MON (ESC) button. The LCD display will return to Step 4.

- Press the ENTER or CAM (SET) button again.  
The specified recorder number and unit number will be set for the selected HDD-unit map.  
"Memory" will appear on the LCD for a few seconds, and the LCD display will return to Step 1.

```

HDD-Unit Map      409
HDD06             Memory
  
```

```

LCD Title F1-F4   410
F1         F2     F3     F4
  
```

When "F1 — F4" is selected

```

LCD Title F1-F4   410
F5         F6     F7     F8
  
```

When "F5 — F8" is selected

## To delete a HDD-unit map

- Perform Step 1 and 2 in p. 67.
- Press the CLEAR button.  
"Clear OK?" will appear on the LCD.

```

HDD-Unit Map      409
HDD06             Clear OK?
  
```

**Note:** To cancel deleting the setting, press the EXIT or MON (ESC) button.

- Press the ENTER or CAM (SET) button.  
The HDD-unit map will be deleted.  
"Erased" will appear on the LCD for a few seconds, and the LCD display will return to Step 1.

```

HDD-Unit Map      409
HDD06             Erased
  
```

**Note:** After all the HDD-unit maps have been deleted, "HDD00" will appear for the camera channel area. "HDD-Unit Map Check" menu will appear on the LCD.

- Select desired characters by performing either of the following.
  - Rotate the JogDial clockwise or counterclockwise.
  - Press the + or - button.

### Notes:

- To move the cursor, rotate the shuttle ring (clockwise or counterclockwise) or move the 3D joystick (to the right or left)
- To delete a character, press the CLEAR button.
- To display the next or previous character group, rotate the JogDial while holding down the SHIFT button. (For example, when the cursor is pointed on "C", "a" can be displayed by rotating the JogDial clockwise while holding down the SHIFT button.)
- The following diagram describes the available characters.

Character group	Characters
Space	" "(Space) ■
Capital letters	ABCDEFGHIJKLMNOPQRSTUVWXYZ
Small letters	abcdefghijklmnopqrstuvwxyz
Numerics	0123456789
Symbols	!"#\$%&'()*+,-./:;<=>?[¥]^_{ }~→←@

- Press the ENTER or CAM (SET) button.  
"Set OK?" will appear on the LCD.

```

LCD Title F1-F4   410
Set OK?
  
```

**Note:** To cancel the setting, press the EXIT or MON (ESC) button. The LCD display will return to Step 4.

- Press the ENTER or CAM (SET) button again.  
The LCD title you have edited will be registered.  
"Memory" will appear on the LCD for a few seconds, and the LCD display will return to Step 1.

```

LCD Title F1-F4   410
Memory
  
```

## ● LCD Title Editing

You can edit button function titles displayed on the LCD. If you set LCD titles related to the registered button functions, controllability will be improved.

- Display "LCD Title" sub menu. (Refer to Step 1 to 4 of p. 51 To Recall Menu Functions.)

```

LCD Title          410
F1-F4             F5-F8
  
```

- Select a desired title group (F1-F4 or F5-F8) by rotating the shuttle ring or moving the 3D joystick.
- Press the ENTER or CAM (SET) button.  
The title editing form will appear on the LCD.

## ■ Joystick Button Functions

If you register a joystick button function to a function button or joystick function button, you can activate the associated function only with pressing the button.

## ● Camera Function

You can recall camera functions by entering function numbers from this system controller.

**Note:** Refer to the operating instruction of camera for details on camera function.

1. Display "Camera Function" sub menu. (Refer to Step 1 to 4 of p. 51 To Recall Menu Functions.)

```
Camera Function  501
"Input Code Number"
```

- 2 Enter a camera function number by pressing the numeric buttons. The entered number will appear on the LCD.

```
Camera Function  ___7
"Enter F1 Button"
```

### Notes:

- To cancel the numeric entry, press the CLEAR button.
- If you press the CAM (SET) button, the image of selected camera will be displayed on the active monitor, and the LCD will return to the default status.

3. Press the F1 button.

- The associated camera function will be activated.
- The specified camera function will blink on the LCD for a few seconds, and the LCD display will return to Step 1.

```
Camera Function  501
Code=___7
```

**Note:** When the camera function has been activated by the A button, the LCD display will become as follows.

```
Camera Function  A
Code=0007
```

## ● System Function

You can recall system functions by entering function numbers from this system controller.

**Note:** Refer to the operating instruction of system unit for details on system function.

1. Display "Camera Function" sub menu. (Refer to Step 1 to 4 of p. 51 To Recall Menu Functions.)

```
System Function  502
"Input Code Number"
```

2. Enter a system function number by pressing the numeric buttons. The entered number will appear on the LCD.

```
System Function  ___5
"Enter F1 Button"
```

### Notes:

- To cancel the numeric entry, press the CLEAR button.
- If you press the CAM (SET) button, the image of selected camera will be displayed on the active monitor, and the LCD will return to the default status.

3. Press the F1 button.

- The associated system function will be activated.
- The specified system function will blink on the LCD for a few seconds, and the LCD display will return to Step 1.

```
System Function  502
Code=___5
```

**Note:** When the system function has been activated by the A button, the LCD display will become as follows.

```
System Function  A
Code=0018
```

## ● Auto Pan

You can activate the auto pan mode for the selected camera.

**Note:** Refer to the operating instruction of camera for details of this function.

1. Display "Auto Pan" sub menu. (Refer to Step 1 to 4 of p. 51 To Recall Menu Functions.)

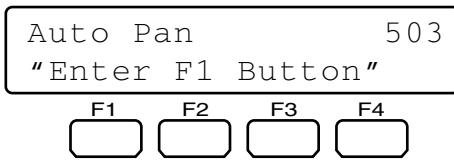

2. Press the F1 button.  
The auto pan mode will be activated.

**Note:** When the auto pan function has been activated with the A button, the LCD display will become as follows.

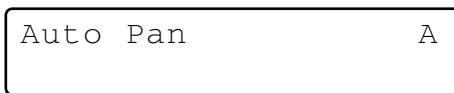

## ● Camera Sequence

You can activate the camera sequence mode for the selected camera.

**Note:** Refer to the operating instruction of camera for details of this function.

1. Display "Camera Sequence" sub menu. (Refer to Step 1 to 4 of p. 51 To Recall Menu Functions.)

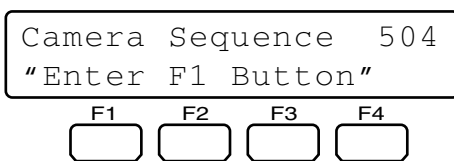

2. Press the F1 button.  
The camera sequence mode will be activated.

**Note:** When the camera sequence mode has been activated with the A button, the LCD display will become as follows.

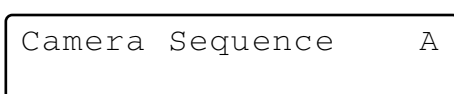

## ● Camera Sort

You can activate the auto sort mode for the selected camera.

**Note:** Refer to the operating instruction of camera for details of this function.

1. Display "Camera Sort" sub menu. (Refer to Step 1 to 4 of p. 51 To Recall Menu Functions.)

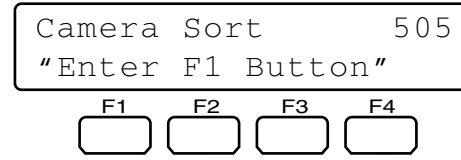

2. Press the F1 button.  
The camera sort mode will be activated.

**Note:** When the camera sort mode has been activated with the A button, the LCD display will become as follows.



## ● Patrol Play

You can activate the patrol play function for the selected camera.

**Note:** Refer to the operating instruction of camera for details of this function.

1. Display "Patrol Play" sub menu. (Refer to Step 1 to 4 of p. 51 To Recall Menu Functions.)

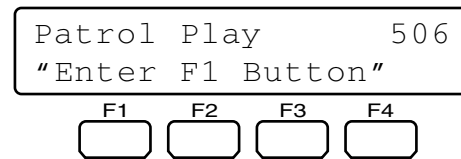

2. Press the F1 button.  
The patrol play mode will be activated.

**Note:** When the patrol play mode has been activated with the A button, the LCD display will become as follows.

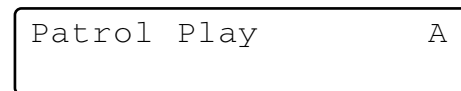

## ● Home Position

You can move the selected camera to the home position.

**Note:** Refer to the operating instruction of camera for details of this function.

1. Display "Home Position" sub menu. (Refer to Step 1 to 4 of p. 51 To Recall Menu Functions.)

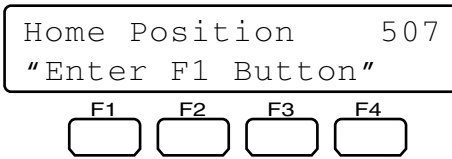

2. Press the F1 button.  
The camera will move to the home position.

**Note:** When the home position has been activated with the A button, the LCD display will become as follows.

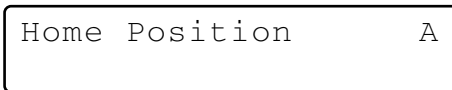

## ● Auto Focus

You can activate the auto focus function for the selected camera.

**Note:** Refer to the operating instruction of camera for details of this function.

1. Display "Auto Focus" sub menu. (Refer to Step 1 to 4 of p. 51 To Recall Menu Functions.)

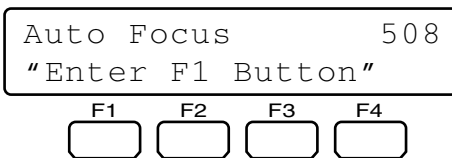

2. Press the F1 button.  
The auto focus function will be activated.

**Note:** When the auto focus function has been activated with the A button, the LCD display will become as follows.



## ● Iris Reset

You can activate the iris reset function for the selected camera.

**Note:** Refer to the operating instruction of camera for details of this function.

1. Display "Iris Reset" sub menu. (Refer to Step 1 to 4 of p. 51 To Recall Menu Functions.)

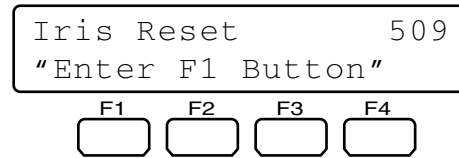

2. Press the F1 button.  
The iris reset function will be activated.

**Note:** When the iris reset function has been activated with the A button, the LCD display will become as follows.



## ● Camera +1

You can change the camera image on the monitor to the higher channel.

1. Display "Camera +1" sub menu. (Refer to Step 1 to 4 of p. 51 To Recall Menu Functions.)

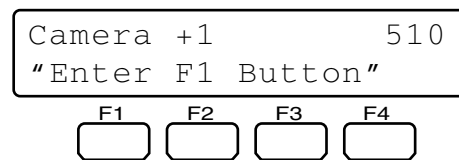

2. Press the F1 button.  
The image of higher camera channel will be displayed on the active monitor.

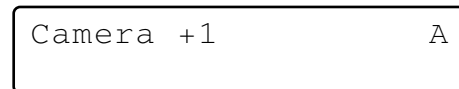

**Note:** When the Camera +1 function has been activated with the A button, the LCD display will become as follows.

## ● Camera -1

You can change the camera image on the monitor to the lower channel.

1. Display "Camera -1" sub menu. (Refer to Step 1 to 4 of p. 51 To Recall Menu Functions.)

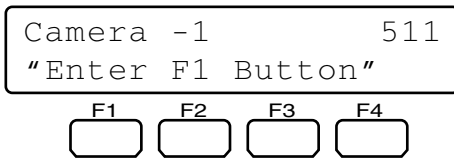

2. Press the F1 button.  
The image of lower camera channel will be displayed on the active monitor.

**Note:** When the Camera -1 function has been activated with the A button, the LCD display will become as follows.

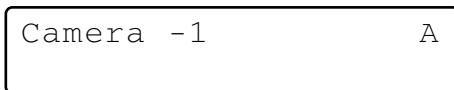

## ● A - B Repeat Playback (WJ-HD300 Series Only)

The description is the same as that of button function. Refer to p. 57 A - B Repeat Playback Setting.

**Note:** Refer to the operating instruction of recorder for details of this function.

1. Display "HD300 A - B Repeat" sub menu. (Refer to Step 1 to 4 of p. 51 To Recall Menu Functions.)

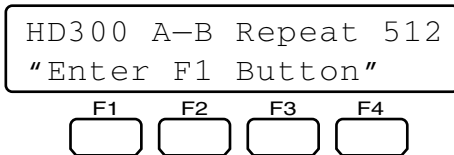

2. Press the F1 button at the point you wish to start playback.  
The playback start point (A) will be set, and "Start" will appear on the LCD for a few seconds.

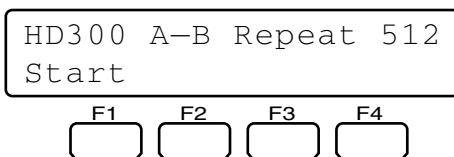

3. Press the F1 button again at the point you wish to end playback. The playback end point (B) will be set, and "End" will appear on the LCD for a few seconds. Then, the repeat playback will be performed between (A) and (B).

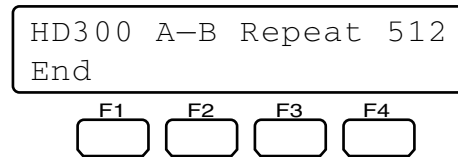

### Notes:

- To quit the repeat playback, press the F1 button again. "Cancel" will appear on the LCD for a few seconds.



- When the A - B repeat playback function has been activated with the function button, the LCD display will become as follows.

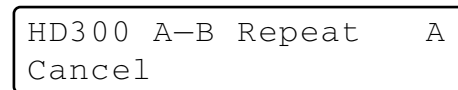
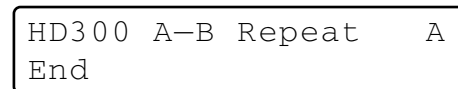

## ● Recorded-image Copy (WJ-HD500 Series Only)

You can copy recorded images from the built-in hard disk to an external recording device.

**Note:** Refer to the operating instruction of recorder for details of this function.

1. Display "HD500 Copy" sub menu. (Refer to Step 1 to 4 of p. 51 To Recall Menu Functions.)

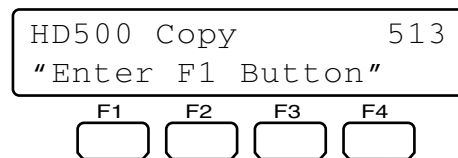

2. Press the F1 button.  
The record copy function will be activated.

**Note:** When the record copy function has been activated with the A button, the LCD display will become as follows.



HD500 Copy A

## ● Alarm Search (WJ-HD200 Series / WJ-HD100 Series)

You can move the playback start point to the next alarm record of recorded image data.

**Note:** Refer to the operating instruction of recorder for details of this function.

1. Display "HD200 Alm Search" sub menu. (Refer to Step 1 to 4 of p. 51 To Recall Menu Functions.)

HD200 Alm Search 514  
"Enter F1 Button"



2. Press the F1 button.  
The alarm search function will be activated.

**Note:** When the alarm search function has been activated with the A button, the LCD display will become as follows.

HD200 Alm Search A

## ● Multiscreen Display

You can change the multiscreen segment patterns of monitor connected to the selected system unit.

**Note:** Available multiscreen segment patterns differ depending on system units. Refer to the operating instructions of system units.

1. Display a desired sub menu among the following. (Refer to Step 1 to 4 of p. 51 To Recall Menu Functions.)

### 4-segment multiscreen display

Multi 4-Seg 515  
"Enter F1 Button"



### 7-segment multiscreen display

Multi 7-Seg 516  
"Enter F1 Button"

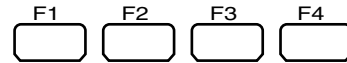

### 9-segment multiscreen display

Multi 9-Seg 517  
"Enter F1 Button"

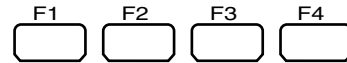

### 10-segment multiscreen display

Multi 10-Seg 518  
"Enter F1 Button"



### 13-segment multiscreen display

Multi 13-Seg 519  
"Enter F1 Button"

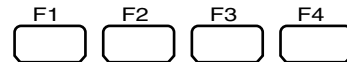

### 16-segment multiscreen display

Multi 16-Seg 520  
"Enter F1 Button"

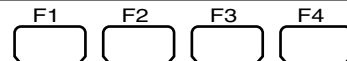

2. Press the F1 button.  
The multiscreen display function will be activated.

**Note:** When the multiscreen display function has been activated with the A button, the LCD display will become as follows.

Multi 4-Seg A

# TROUBLESHOOTING

Check the following before requesting repair.

If a trouble cannot be corrected even after checking and trying remedy, contact your dealer.

Problem	Check item and Remedy	Reference
The power of system controller is not turned on.	The AC adapter may be disconnected from either the system controller or the AC outlet. Check the connection.	Refer to p. 27.
	The DC plug may not be firmly plugged into the DC 9 V Input jack of system controller. Check the connection.	Refer to p. 27.
The brightness of LCD is not enough. / Characters do not appear on the LCD.	The display setting value of LCD may be improper. Check the setting.	Refer to p. 28.
Login standby display does not appear on the LCD	The settings of MODE switches at the rear panel may be wrong. Check the settings and turn on the power again.	Refer to p. 18.
	The setting of CONTROLLER NO. switch may be wrong. Check the setting and turn on the power again.	Refer to p. 18.
	You may have turned on the power while some buttons of system controller was held down. Check no buttons are being held down, and turn on the power again.	Refer to p. 27.
Users cannot control cameras with the 3D joystick.	The cable may be disconnected from either the main unit or 3D joystick unit. Check the connection.	Refer to p. 17.
	The combination codes of main unit and 3D joystick unit may not be identical. Check their combination codes.	Refer to p. 17.
	Users who have logged into the system may not be authorized to control cameras with the 3D joystick. Check the user level settings of these users.	Refer to pp. 62 to 65.
Users cannot log into the system.	Cables may be disconnected from either the DATA ports of system controller or other system units. Check the connections.	Refer to p. 16.
	The line termination settings of MODE switches may be wrong. Check the settings and turn on the power again.	Refer to p. 18.
	You may have entered a wrong user ID. Reenter the user ID correctly.	Refer to p. 29.
	You may have entered a wrong password. If the password is wrong, the LCD will return to the login standby display. Reenter the password correctly.	Refer to p. 29.

<b>Problem</b>	<b>Check item and Remedy</b>	<b>Reference</b>
Buzzer sound is not heard.	The buzzer may be set to OFF. Check the setting.	Refer to pp. 28 or 29.
You cannot activate any functions even when pressing the A, B, or top button of the 3D joystick unit.	The cable may be disconnected from either the system controller and 3D joystick. Check the connection.	Refer to p. 17.
	Function assignment settings of the A, B or top button may be wrong. Check the settings.	Refer to pp. 53 and 54.
	Users who have logged into the system may not be authorized to control cameras with these buttons. Check the user level settings of these users.	Refer to pp. 62 to 65.
"Controller No.1 No Exist Error" is displayed on the LCD.	There may be no system controller set to CONTROLLER NO. 1. A system controller must be set to CONTROLLER NO.1. Check the CONTROLLER NO. switch at the rear panel of each system controller.	Refer to p. 18.
You cannot activate any functions even when pressing the function buttons (F1 to F4/F5 to F8).	Function assignment settings of the F1 to F8 buttons may be wrong. Check the settings.	Refer to pp. 52 to 54.
	Users who have logged into the system may not be authorized to control cameras with these buttons. Check the user level settings of these users.	Refer to pp. 62 to 65.
When pressing one of the function buttons (F1 to F4/F5 to F8), there is a difference between the function displayed on the LCD and that recalled actually.	Function assignment settings of the F1 to F8 buttons may be wrong. Check the settings.	Refer to pp. 52 to 54.
	The LCD title may have been edited wrongly. Check the setting.	Refer to p. 68.
There is an invalid button even when it is pressed.	Can the selected monitor, camera, or system unit activate the function assigned to the button? Depending on system devices, available functions will differ. Refer to the operating instructions of selected system unit.	—
	Users who have logged into the system may not be authorized to control cameras with the button. Check the user level settings of these users.	Refer to pp. 62 to 65.
Operation is suddenly discontinued while controlling system units.	There may be a user controlling system units from another system controller. Check that no users are controlling other system controllers.	—
"ALM SUSPEND" indicator light up or goes out even when no system unit is controlled.		
The power cord insulation is damaged.	The power cord or the plug is damaged. If you continue to use it, a fire or an electric shock may occur. Unplug the AC adapter immediately, and refer servicing to qualified service personnel.	—
The power cord and the power plug of the AC adapter are hot during use.		—
The power cord gets warm or hot if bent or pulled during use.		—

# SPECIFICATIONS

## ● System Controller

Power Source:	9 V DC, 300 mA (using the supplied AC adapter)
Power Source (Supplied AC Adapter):	120 V AC, 60 Hz, 200 mA
Data Output/Input Port:	6-conductor modular jack (RS-485, Full duplex) x2
Serial port:	9-pin D-sub connector
Controller Number:	1 to 8 (rotary switch)
Ambient Operating Temperature:	-10 °C to + 50 °C {14 °F to 122 °F}
Unit Number Selection:	1 to 99
Monitor Number Selection:	1 to 99
Camera Number Selection:	1 to 256
Dimensions	
Main Unit:	290 mm (W) x 111 mm (H) x 221 mm (D) {11-7/16 in. (W) x 4-3/8 in. (H) X 8-11/16 in. (D)}
3D joystick Unit:	134 mm (W) x 146 mm (H) x 218 mm (D) {5-1/4 in. (W) x 5-3/4 in. (H) x 8-9/16 in. (D)}
Weight	
Main Unit:	1.3 kg {2.9 lbs.} (without the AC adapter)
3D joystick Unit:	0.8 kg {1.8 lbs.}

## ● DATA Port

### RS-485 Port

System controller's rear panel

Internal block

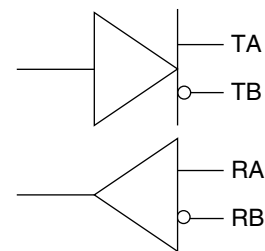
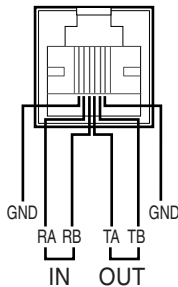

# STANDARD ACCESSORIES

Operating Instructions (This Document) ..... 1 pc.

The following parts are used during installation procedures.

AC Adapter (UL Listed, Model No: N0JBEF000001) ..... 1 pc.

6-conductor Modular Cable (3 m) ..... 1 pc.



**Panasonic Digital Communications & Security Company**  
Unit of Matsushita Electric Corporation of America

**Security Systems Group**  
[www.panasonic.com/cctv](http://www.panasonic.com/cctv)

**Executive Office:** One Panasonic Way 3E-7, Secaucus, New Jersey 07094  
**Zone Office**

**Eastern:** One Panasonic Way, Secaucus, NJ 07094 (201) 348-7303

**Central:** 1707 N.Randal Road, Elgin, IL 60123 (847) 468-5205

**Western:** 6550 Katella Ave., Cypress, CA 90630 (714) 373-7840

**PANASONIC CANADA INC.**

5770 Ambler Drive, Mississauga,  
Ontario, L4W 2T3 Canada (905)624-5010

**PANASONIC SALES COMPANY**

**DIVISION OF MATSUSHITA ELECTRIC OF PUERTO RICO INC.**

San Gabriel Industrial Park 65th Infantry Ave. KM. 9.5 Carolina,  
P.R. 00985 (809)750-4300